



USER'S MANUAL



COMPEX NETPASSAGE SERIES

WP54AG

WP54AG

WP54AG

WP54AG

WP54AG

© Copyright 2006 Compex Systems Pte Ltd

All Rights Reserved

This document contains information, which is protected by copyright. Reproduction, adaptation or translation without prior permission is prohibited, except as allowed under the copyright laws.

Trademark Information

Compex®, ReadyLINK® and MicroHub® are registered trademarks of Compex, Inc. Microsoft Windows and the Windows logo are the trademarks of Microsoft Corp. NetWare is the registered trademark of Novell Inc. All other brand and product names are trademarks or registered trademarks of their respective owners.

Notice: Copyrights © 2006 by Compex, Inc. All rights reserved. Reproduction, adaptation, or translation without prior permission of Compex, Inc. is prohibited, except as allowed under the copyright laws.

Manual Revision by Daniel

Manual Number: U-0524-V1.3 Version 1.3 October 2006

Disclaimer

Compex, Inc. provides this manual without warranty of any kind, expressed or implied, including but not limited to the implied warranties of merchantability and fitness for a particular purpose. Compex, Inc. may make improvements and/or changes to the product and/or specifications of the product described in this manual, without prior notice. Compex, Inc will not be liable for any technical inaccuracies or typographical errors found in this guide. Changes are periodically made to the information contained herein and will be incorporated into later versions of the manual. The information contained is subject to change without prior notice.

Your Feedback

We value your feedback. If you find any errors in this user's manual, or if you have suggestions on improving, we would like to hear from you. Please contact us at:

Fax: (65) 62809947

Email: feedback@compex.com.sg

FCC NOTICE

This device has been tested and found to comply with the limits for a Class B digital device, pursuant to Part 15 of the FCC Rules. These limits are designed to provide reasonable protection against harmful interference in a residential installation. This device generates, uses and can radiate radio frequency energy and, if not installed and used in accordance with the instructions, may cause harmful interference to radio communications. However, there is no guarantee that interference will not occur in a particular installation. If this device does cause harmful interference to radio or television reception, the user is encouraged to try to correct the interference by one or more of the following measures:

- Reorient or relocate the receiving antenna.
- Connect the computer into an outlet on a circuit different from that to which the receiver is connected.
- Increase the separation between the computer and receiver.
- Consult the dealer or an experienced radio/TV technician for help.

Caution: Any changes or modifications not expressly approved by the grantee of this device could void the user's authority to operate the equipment.

FCC Compliance Statement: This device complies with Part 15 of the FCC Rules. Operation is subject to the following two conditions:
This device may not cause harmful interference, and
This device must accept any interference received, including interference that may cause undesired operation.

Products that contain a radio transmitter are labelled with FCC ID and may also carry the FCC logo.

Caution: Exposure to Radio Frequency Radiation.

To comply with the FCC RF exposure compliance requirements, the following antenna installation and device operating configurations must be satisfied:

- a. For configurations using the integral antenna, the separation distance between the antenna(s) and any person's body (including hands, wrists, feet and ankles) must be at least 2.5cm (1 inch).
- b. For configurations using an approved external antenna, the separation distance between the antenna and any person's body (including hands, wrists, feet and ankles) must be at least 20cm (8 inch).

The transmitter shall not be collocated with other transmitters or antennas.

ICES 003 Statement

This Class B digital apparatus complies with Canadian ICES-003.

Declaration of Conformity

Compex, Inc. declares the following:

Product Name: Wireless Access Point with PoE

Model No.: WP54AG conforms to the following Product Standards:

This device complies with the Electromagnetic Compatibility Directive (89/336/EEC) issued by the Commission of the European Community. Compliance with this directive implies conformity to the following European Norms (in brackets are the equivalent international standards.)

Electromagnetic Interference (Conduction and Radiation): EN 55022 (CISPR 22)

Electromagnetic Immunity: EN 55024 (IEC61000-4-2, 3,4,5,6,8,11)

Low Voltage Directive: EN 60 950: 1992+A1: 1993+A2: 1993+A3: 1995+A4: 1996+A11: 1997.

Therefore, this product is in conformity with the following regional standards:

FCC Class B: following the provisions of FCC Part 15 directive, **CE Mark**: following the provisions of the EC directive.

Compex, Inc. also declares that:

The wireless card in this product complies with the R&TTE Directive (1999/5/EC) issued by the Commission of the European Community. Compliance with this directive implies conformity to the following:

EMC Standards: FCC: 47 CFR Part 15, Subpart B, 47 CFR Part 15, Subpart C (Section 15.247); CE: EN 300 328-2, EN 300 826 (EN 301 489-17)

Therefore, this product is in conformity with the following regional standards:

FCC Class B: following the provisions of FCC Part 15 directive, **CE Mark**: following the provisions of the EC directive.

Technical Support Information

The warranty information and registration form are found in the Quick Install Guide.

For technical support, you may contact Compex or its subsidiaries. For your convenience, you may also seek technical assistance from the local distributor, or from the authorized dealer/reseller that you have purchased this product from. For technical support by email, write to support@compex.com.sg.

Refer to the table below for the nearest Technical Support Centres:

Technical Support Centres	
Contact the technical support centre that services your location.	
U.S.A., Canada, Latin America and South America	
 Write	Compex, Inc. 840 Columbia Street, Suite B Brea, CA 92821, USA
 Call	Tel: +1 (714) 482-0333 (8 a.m.-5 p.m. Pacific time) Tel: +1 (800) 279-8891 (Ext.122 Technical Support)
 Fax	Fax: +1 (714) 482-0332
Asia, Australia, New Zealand, Middle East and the rest of the World	
 Write	Compex Systems Pte Ltd 135, Joo Seng Road #08-01, PM Industrial Building Singapore 368363
 Call	Tel: (65) 6286-1805 (8 a.m.-5 p.m. local time) Tel: (65) 6286-2086 (Ext.199 Technical Support)
 Fax	Fax: (65) 6283-8337
Internet access/	E-mail: support@compex.com.sg FTPsite: ftp.compex.com.sg
Website:	http://www.cpx.com or http://www.compex.com.sg

About This Document

The product described in this document, Wireless Access Point with PoE, WP54AG is a licensed product of Compex Systems Pte Ltd. This document contains instructions for installing, configuring and using Access point. It also gives an overview of the key applications and the networking concepts with respect to the product.

This documentation is for both Network Administrators and the end user who possesses some basic knowledge in the networking structure and protocols.

It makes a few assumptions that the host computer has already been installed with TCP/IP and already up & running and accessing the Internet. Procedures for Windows 98SE/ME/2000/XP operating systems are included in this document. However, for other operating system, you may need to refer to your operating system's documentation for networking.

How to Use this Document

This document may become superseded, in which case you may find its latest version at: <http://www.compex.com.sg>

The document is written in such a way that you as a user will find it convenient to find specific information pertaining to the product. It comprises of chapters that explain in details on the installation and configuration of WP54AG.

Firmware

This manual is written based on Firmware version 1.48.

Conventions

In this document, special conventions are used to help and present the information clearly. The Wireless Access Point with PoE is often referred to as *WP54AG* or *access point* or *AP* in this document. Below is a list of conventions used throughout.



NOTE

This section will consist of important features or instructions



CAUTION

This section concerns risk of injury, system damage or loss of data



WARNING

This section concerns risk of severe injury

References on Menu Command, Push Button, Radio Button, LED and Label appear in **Bold**. For example, "Click on **Ok**."

Copyrights © 2006 Complex Systems Pte Ltd	i
Trademark Information	i
Disclaimer.....	i
Your Feedback.....	i
FCC NOTICE	ii
Declaration of Conformity	ii
Technical Support Information	iii
About This Document.....	iv
How to Use this Document	iv
Firmware	iv
Conventions.....	iv

CHAPTER 1: PRODUCT OVERVIEW..... 1

Introduction.....	1
Features and Benefits.....	2
When to use which mode	4
Access Point Mode.....	4
Access Point Client Mode	5
Point to Point Mode	6
Point to Multiple point Mode	7
Wireless Routing Client Mode	8
Gateway Mode.....	9
Wireless Adapter Mode	11

CHAPTER 2: HARDWARE INSTALLATION 12

Setup Requirements	12
Hardware Installation	12
OPTION One: Using power adapter to supply power to the unit.....	12
OPTION Two: Using PoE to supply power to the unit.....	14
Optional: Mounting on the Wall	17

CHAPTER 3: ACCESS TO WEB-BASED INTERFACE 18

Access to the Web interface with uConfig.....	18
Manual access to web-based interface via Internet Explorer	22

CHAPTER 4: COMMON CONFIGURATION27

Management Port Setup.....	27
----------------------------	----

Setting up your LAN	28
To view the active DHCP leases	31
To reserve specific IP addresses for predetermined DHCP clients	32
WLAN Setup	35
To configure the Basic setup of the wireless mode	36
To configure the Security setup of the wireless mode.....	51
To configure the Advanced setup of the wireless mode	51
Statistics.....	53
WAN Setup.....	60
Telnet/SSH Setup.....	68
TELNET Command Line Interface	71
Secure Shell Host Command Line Interface	72
WEB Mode	74
SNMP Setup	75
STP Setup.....	76
MAC Filtering.....	82
<i>Add a MAC address to the MAC Address List.</i>	83
<i>Delete a MAC address from all access points.</i>	86
<i>Delete a MAC address from individual access point.</i>	88
<i>Edit MAC address from the MAC Address List.</i>	90
 CHAPTER 5: WLAN SECURITY	 92
How to set up WEP	93
How to set up WPA-Personal.....	95
How to set up 802.1x/RADIUS.....	97
How to set up WPA Enterprise.....	99
 CHAPTER 6: WIRELESS EXTENDED FEATURES	 102
Access Control – The Wireless Pseudo VLAN.....	102
Wireless Pseudo VLAN Per Node	103
Wireless Pseudo VLAN Per Group.....	106
Wireless Setup - The Wireless Distributed System.....	110
Long Distance Parameters	116
 CHAPTER 7: ADVANCED CONFIGURATION	 119
Routing.....	119
To configure Static Routing of WP54AG	120
NAT.....	121
To configure Virtual Servers based on De-Militarized Zone Host	122
To configure Virtual Servers based on Port Forwarding	124

To configure Virtual Servers based on IP Forwarding	127
Bandwidth Control.....	128
To enable or disable Bandwidth Control.....	128
To configure WAN Bandwidth Control Setting	129
To configure LAN Bandwidth Control Setting	130
Remote Management.....	132
To set up Remote Management.....	132
Parallel Broadband.....	133
To enable Parallel Broadband on WP54AG.....	134
Email Notification.....	135
Static Address Translation.....	137
DNS Redirection	139
To enable/disable DNS Redirection.....	141
Dynamic DNS Setup	141
To enable/disable Dynamic DNS Setup.....	142
To manage Dynamic DNS List.....	142

CHAPTER 8: SECURITY CONFIGURATION 148

Packet Filtering	148
To configure Packet Filtering.....	148
URL Filtering	152
To configure URL Filtering.....	152
Firewall Configuration	153
To configure SPI Firewall.....	153
Firewall Logs.....	157
To view Firewall Logs.....	157

CHAPTER 9: SYSTEM UTILITIES 158

Using the SYSTEM TOOLS Menu.....	158
Ping Utility.....	158
Syslog.....	159
System Identity.....	160
System Clock Setup	161
Firmware Upgrade.....	162
Backup or Reset Settings	164
Reboot System.....	167
Change Password.....	168
Logout.....	169
Using the HELP menu	170
Get Technical Support	170
About System.....	171

APPENDIX I: FIRMWARE RECOVERY172

APPENDIX II: TCP/IP CONFIGURATION174

 For Windows 95/98/98SE/ME/NT 174

 For Windows XP/2000..... 177

APPENDIX III: PANEL VIEWS & DESCRIPTIONS180

APPENDIX IV: COMMAND LINE INTERFACE COMMANDS...183

APPENDIX V: TECHNICAL SPECIFICATIONS188

Chapter 1: Product Overview

INTRODUCTION

The Wireless Access Point is a high-performance access point (AP) that is designed for enterprise and public access applications. Embedded with the Atheros chipset, it boasts network robustness, stability and wider network coverage. Based on 802.11g, the access point supports high-speed data transmission of up to 54Mbps in the 2.4GHz and 5GHz frequency band.

The access point is capable of operating in 7 modes: **Access Point**, **Access Point Client**, **Point-to-Point**, **Point-to-Multi Point**, **Wireless Routing Client**, **Gateway** and **Wireless Adapter**. Which makes it suitable for a wide variety of wireless applications, including long-distance deployments.

Equipped with an SMA connector for external antenna support, the access point provides a wider coverage for your network. Moreover, its integrated Power over Ethernet (PoE) allows the access point to be used in areas where power outlets are not readily available.

To protect your security and privacy, the access point is armed with many enhanced wireless security features such as Wi-Fi Protected Access (WPA), WPA2 (with Advanced Encryption Standard encryption) MAC Address Filtering, IEEE 802.1x Authentication and 64/128-bit WEP (Wired Equivalent Privacy) to ensure privacy for the heterogeneous mix of users within the same wireless network.

The access point also incorporates a unique set of advanced features such as: Wireless Distribution System (WDS) to wirelessly link associated access points together and extend network coverage, Long-Range parameter fine-tuning which provide the access point with the ability to auto-calculate parameters such as slot time, ACK time-out and CTS time-out to achieve a longer range; Spanning Tree Protocol (STP) which provides extra redundancy and the ability to auto-reconfigure when there are changes in the network topology; Pseudo VLAN which enables the creation of wireless isolated nodes or workgroups of wireless clients to enhance security in a public access wireless network; HTTPS which feature additional authentication and encryption; and Telnet which allows remote connection; and SSH which provides a secure host connection.

FEATURES AND BENEFITS

The access point has been designed for high performance and offers a rich suite of features, with which you should acquaint yourself to be able to exploit your access point's full potential.

- **Wireless Distribution System (WDS)**
This feature allows linking of several access points, virtually creating a larger network infrastructure that allows mobile users to roam wirelessly, while still being able to access network resources.
- **Wireless Pseudo VLAN**
The Compex unique Wireless Pseudo VLAN technology is a feature that allows wireless clients to be segmented individually or into workgroups, thus blocking access to another user's/group's PCs, and enhancing the privacy of the wireless clients. This is especially useful in public hotspot deployment.
- **Highly Secured Wireless Network**
The access point supports the highest available wireless security standard: Wi-Fi Protected Access 2. WPA2 has two different modes: WPA2-Personal for SOHO users and WPA2-Enterprise for Enterprise users. The access point also supports IEEE 802.1x for secure and centralized user-based authentication. Wireless clients are thus required to authenticate through highly secure methods like EAP-TLS, EAP-TTLS, and EAP-PEAP, in order to obtain access to the network.
- **Smart Select**
This feature will automatically scan and recommend the best channel that the access point can utilize.
- **uConfig Utility**
Compex's exclusive **uConfig** utility allows users to access the user-friendly Web configuration interface of the access point without having to change the TCP/IP setup of the workstation.
- **STP**
Spanning-Tree Protocol provides path redundancy while preventing undesirable loops in the network. It forces certain redundant data paths into a standby (blocked) state. If one network segment in the Spanning-Tree Protocol becomes unreachable, or if Spanning-Tree Protocol costs change, the spanning-tree algorithm reconfigures the spanning-tree topology and re-establishes the link by activating the standby path.

-
- **HTTPS**
WP54AG supports HTTPS (SSL) in addition to the standard HTTP. HTTP (SSL) features additional authentication and encryption for secure communication.
 - **Telnet**
Telnet allows a computer to remotely connect to the WP54AG CLI (Command Line Interface) for control and monitoring.
 - **SSH**
SSH (Secure Shell Host) establishes a secure host connection to the WP54AG CLI for control and monitoring.

WHEN TO USE WHICH MODE

The access point is versatile in the sense that it may operate in six different types of modes: **Access Point Mode**, **Client Mode**, **Point to Point**, **Point to Multiple Point**, **Wireless Routing Client** and **Gateway**.

This section presents a brief outline of the different network applications that can be accommodated through the different modes of the access point.

ACCESS POINT MODE

This is the default mode of your access point. The **Access Point** mode enables you to bridge wireless clients to access the wired network infrastructure and to communicate with each other.

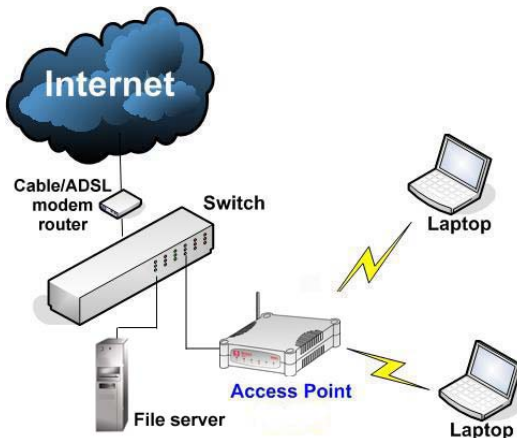

In the example above, the wireless users will be able to access the file server connected to the switch through the access point in **Access Point** mode.

ACCESS POINT CLIENT MODE

In **Access Point Client** mode, the device acts as a wireless client. When connected to an access point, it will create a network link between the Ethernet network connected at this client device, and the wireless and Ethernet network connected at the access point.

In this mode it can only connect with an access point. Other wireless clients cannot connect with it directly unless connected to the same access point - allowing them to communicate with all devices connected at the Ethernet port of the WP54AG.

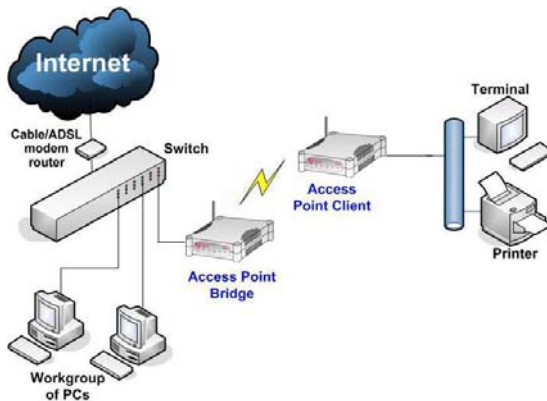

In the example above, the workgroup PCs will be able to access the printer connected to the access point in **Access Point Client** mode.

POINT TO POINT MODE

In **Point to Point** mode, the access point allows point-to-point communication between different buildings. It enables you to bridge wireless clients that are kilometres apart while unifying the networks.

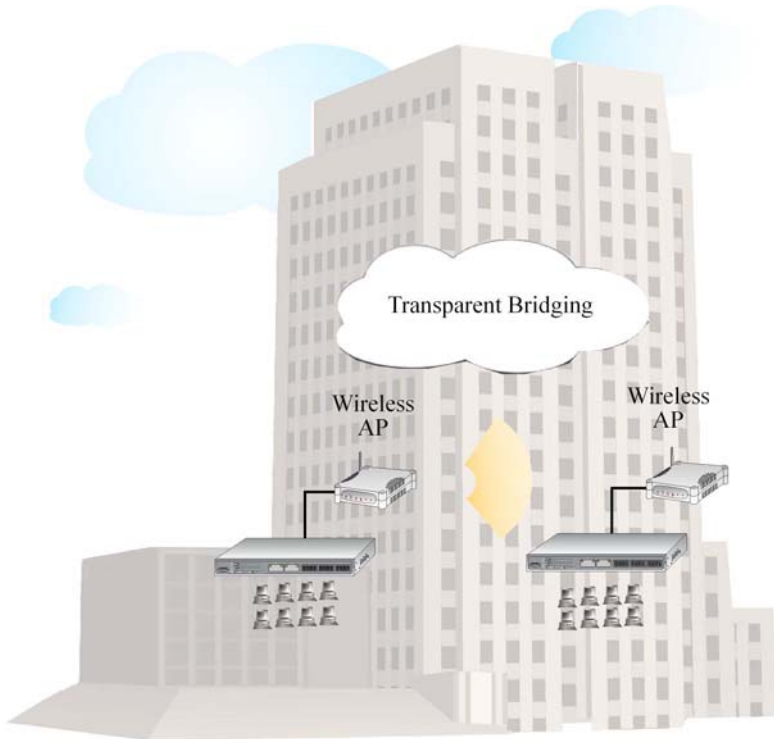

In the example above, you may configure two access points (AP) to perform transparent bridging between two buildings

POINT TO MULTIPLE POINT MODE

In **Point to Multiple Point** mode, this mode is similar to that of the Point-to-Point mode. But the access point located at one facility is able to connect to up to 8 access points (AP) installed in any direction from that facility.

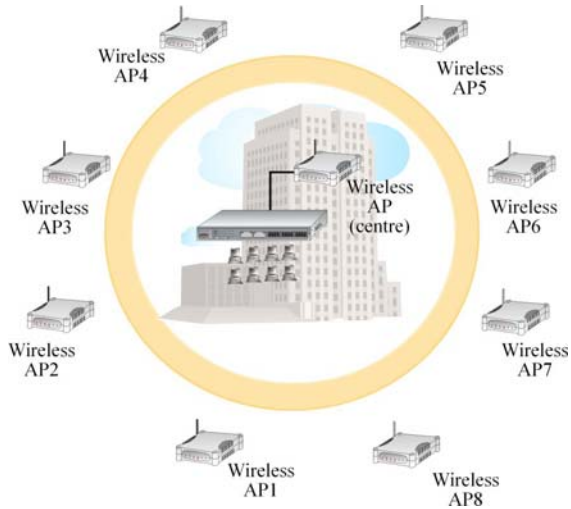

The above illustration describes how this mode operates.

WIRELESS ROUTING CLIENT MODE

An application of this mode would be for the Ethernet port of the **Wireless Routing Client** to be used for connection with other devices on the network while access to the Internet would be achieved through wireless communication with wireless ISP.

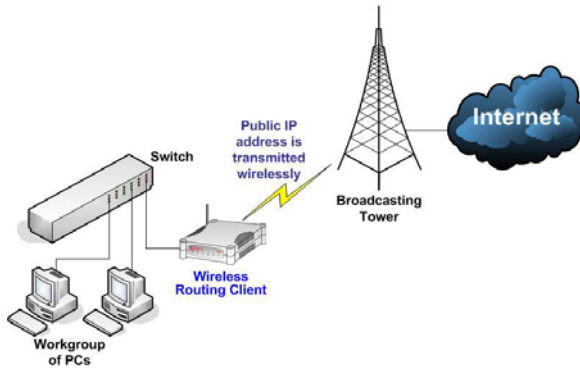

The above illustration describes how this mode operates.

GATEWAY MODE

Or put it more simply, Broadband Internet sharing in a wireless network!

Since the access point supports several types of broadband connections, the first step in setting up the access point as a *Broadband Internet Gateway* is to identify the type of broadband Internet access you are subscribed to.

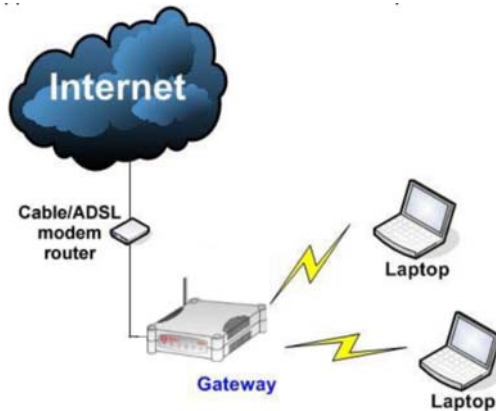

Static IP address

Use this type of connection if you have subscribed to a fixed IP address or to a range of fixed IP addresses from your Internet Service Provider.

Dynamic IP address

When powered using this type of connection, the access point requests for an IP address which will be automatically assigned to it by your Internet Service Provider.

This type of connection applies for instance to:

- Singapore Cable Vision subscribers
- @HOME Cable Service users

PPP over Ethernet (PPPoE)

Select this type of connection if you are using ADSL services in a country utilising standard PPP over Ethernet for authentication.

For instance:

If you are in Germany which uses T-1 connection or

If you are using SingNet Broadband or Pacific Internet Broadband in Singapore.

PPTP

Select this type of connection if you are using ADSL services in a country utilising PPTP connection and authentication.

L2TP

Short for Layer Two (2) Tunneling Protocol, an extension to the PPP protocol that enables ISPs to operate Virtual Private Networks (VPNs). L2TP merges the best features of two other tunneling protocols: PPTP from Microsoft and L2F from Cisco Systems.

WIRELESS ADAPTER MODE

Similarly to the Access Point Client mode, the access point used in this mode, is able to communicate wirelessly with another access point to perform transparent bridging between two networks.

However here, the **Wireless Adapter** connects a single wired workstation only. No client software or drivers are required while using this mode.

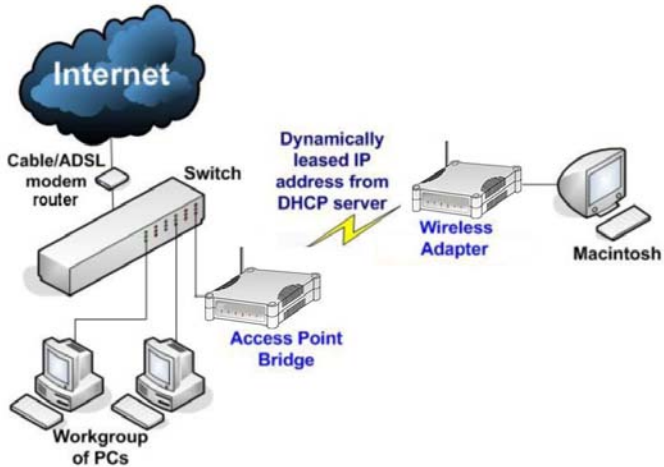

Chapter 2: Hardware Installation

SETUP REQUIREMENTS

Before starting, please verify that the following is available:

- CAT5/5e networking cable
- At least one computer is installed with a Web browser and a wired or wireless network interface adapter
- TCP/IP protocol is installed and IP address parameters are properly configured on all your network's nodes

HARDWARE INSTALLATION

The access point can be powered using either the power adapter provided or a PoE Injector. The installation process for both options is described below.

OPTION ONE: USING POWER ADAPTER TO SUPPLY POWER TO THE UNIT

Step 1:

Connect the external antenna to the SMA connector of the access point.

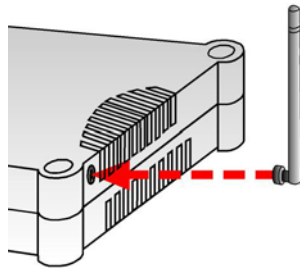

Step 2:

Insert one end of the Ethernet cable to any of the Ethernet ports on your access point, and the other end of the cable to your PC's Ethernet network adapter.

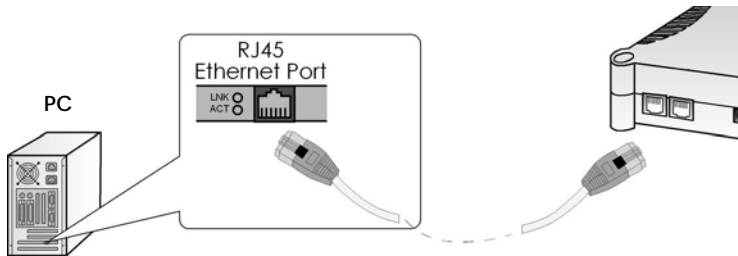

Step 3:

Attach the power adapter to the main electrical supply, and connect the power plug into the socket of the access point.

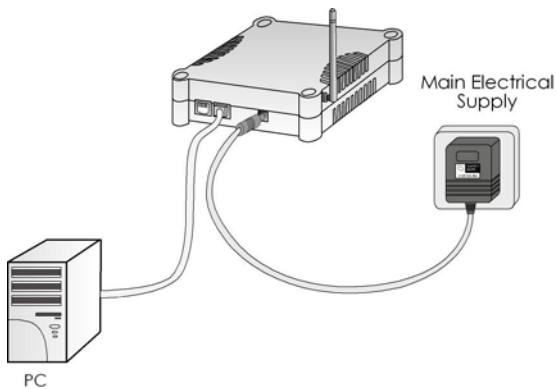

Step 4:

Turn ON the power supply and power ON your PC. Notice that the LEDs: **Power** and Port **1** or **2** (depending on which port you have connected the RJ45 Ethernet cable to) have lighted up. This indicates that connection has been established successfully between your access point and your PC.

OPTION TWO: USING PoE TO SUPPLY POWER TO THE UNIT

The access point is fully compatible with a Power-Over-Ethernet (PoE) kit. A PoE accessory supplies operational power to the wireless AP via the Ethernet cable connection.

Users who have already purchased a PoE and who wish to use it to supply power to the access point may follow the installation procedures shown below:

Step 1:

Connect the external antenna to the SMA connector of the access point.

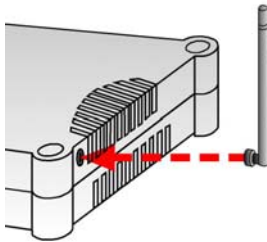

Step 2:

Use an RJ45 Ethernet cable to connect one end of the cable to the LAN OUT port of the Injector and the other end to Ethernet port 1 of the access point.

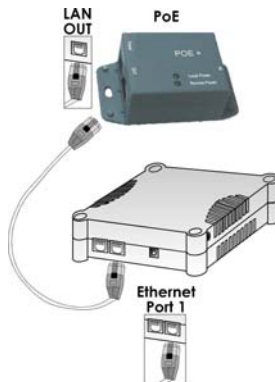

Step 3:

Next, connect the RJ45 Ethernet cable attached to the PoE Injector to your PC's Ethernet network adapter.

Once you have finished configuring your access point, you can connect the PoE Injector's RJ45 Ethernet cable to your network device, such as to a switch or hub.

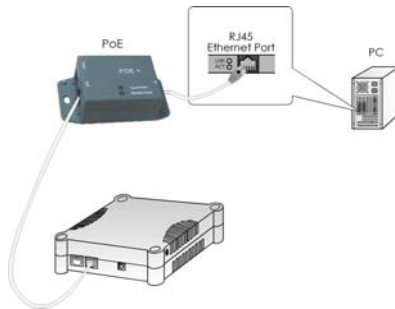

Step 4:

Connect the power adapter supplied in the PoE kit to the main electrical supply and the power plug into the socket of the injector.

Note:

The voltage and current supplied to the power adapter and the PoE kit power adapter are different. Do not interchange the power adapters.

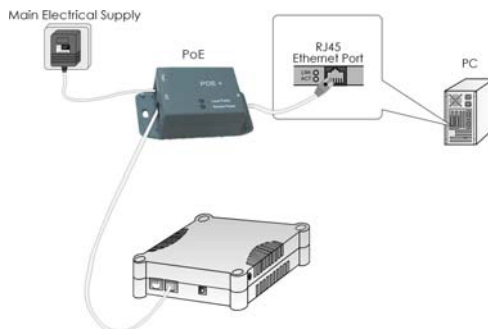

Step 5:

Turn on your power supply. Notice that the **Power** LED has lighted up. This indicates that the access point is receiving power through the Compex PoE Injector. Notice also that the corresponding port LEDs have lighted up. This indicates that connection between your access point and your PC has been established.

OPTIONAL: MOUNTING ON THE WALL

Step 1:

Screw the mount onto the unit.

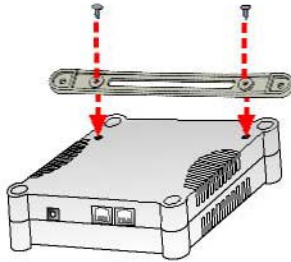

Step 2:

Align the unit and mount to the wall.

Use the mount as a guide, make 2 marks and drill 2 holes into the wall.

Step 3:

Next, secure the unit and mount to the wall.

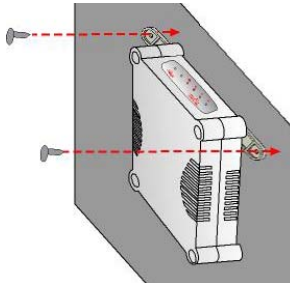

Chapter 3: Access to Web-based Interface

There are two methods to access to the web-based Interface of your access point:

- **Through our Complex Utility – uConfig**
You can access to the web-based interface directly without the need to assign a different IP address to your PC.
- **By entering the IP address of Access point in the address bar of Internet Explorer**
You need to assign an IP address to your PC, such as 192.168.168.x, where **x** can take any value from 2 to 254, so that it is in the same subnet as Access point.

ACCESS TO THE WEB INTERFACE WITH UCONFIG

Complex has developed a powerful uConfig utility that has been designed to give you direct access to the Web interface.

Step 1:

Insert the Product CD into your CD-ROM drive. The CD will run automatically.

Step 2:

From the **Utilities** section, select to install the **uConfig** utility to your hard disk.

Step 3:

When the utility has been installed, double-click on the **uConfig** icon. The following screen will appear, click on the **Yes** button to proceed.

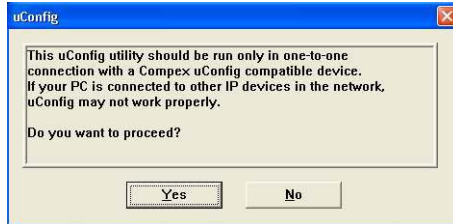

Step 4:

Select **WP54AG** in the **Comex Products List** section and click on the **Open Web** button. To retrieve and display the latest device(s) in the list, click on the **Refresh** button.

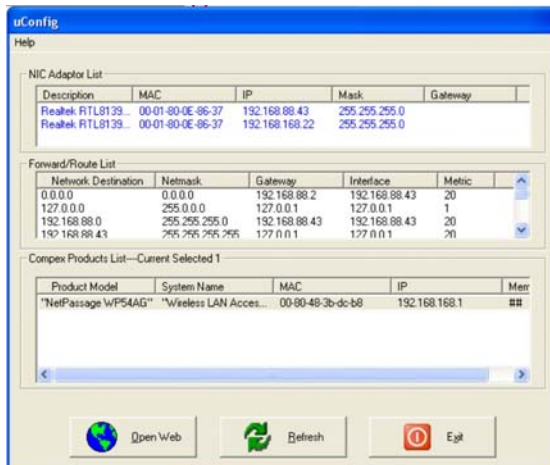

Step 5:

Do not exit the uConfig program while accessing to the web-based interface. This will disconnect you from the device. Click on the **OK** button to proceed.

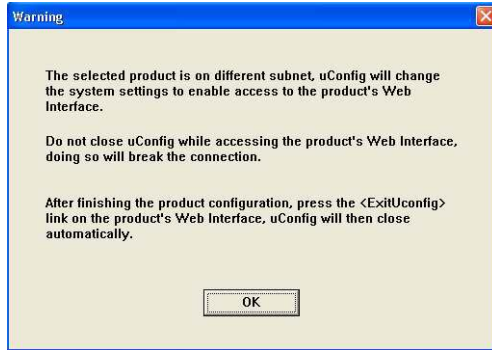

Step 6:

At the login page, press the **LOGIN!** button to enter the configuration page. The default password is "password".



Step 7:

You will then reach the home page of your access point's web-based interface.

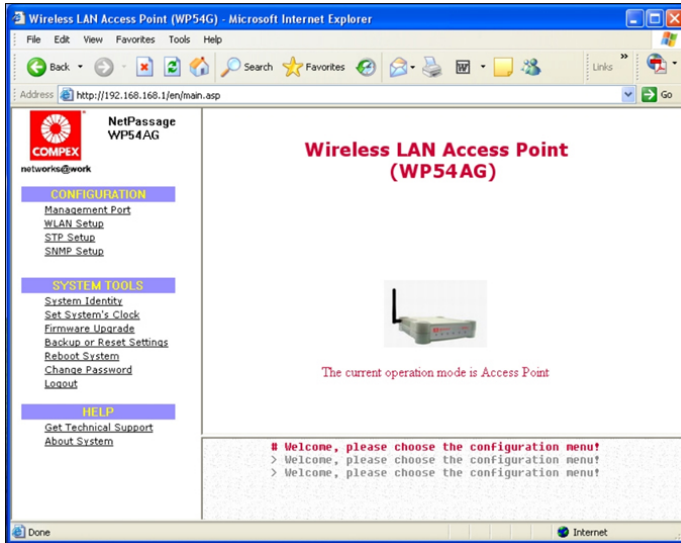

MANUAL ACCESS TO WEB-BASED INTERFACE VIA INTERNET EXPLORER

EXPLORER

For this method, you need to assign an IP address to your PC so that it belongs to the same subnet as your access point. In this example, we are using Windows XP for illustration. For Windows 98/98SE/2000/NT/ME, kindly refer to **Appendix II "TCP/IP Configuration"**.

Step 1:

Go to your desktop, right-click on **My Network Places** icon and select **Properties**.

Step 2:

Go to your network adapter icon, right click and select **Properties**.



Step 3:

Highlight **Internet Protocol (TCP/IP)** and click on the **Properties** button.

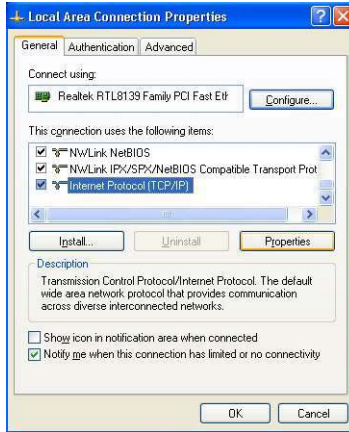

Step 4:

Select the radio button for **Use the following IP address**. Enter the IP Address and Subnet Mask as 192.168.168.x and 255.255.255.0, where **x** can be any number from 2 to 254, except 1. In this example, we are using 192.168.168.160 as the static IP Address.

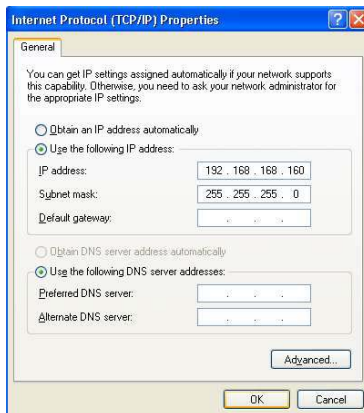

Step 5:

Click on the **OK** button to close all windows.

Step 6:

Next, in order to check if the IP address has been correctly assigned to your PC, go to **Start** menu, **Accessories**, select **Command Prompt** and type the command *ipconfig/all*.

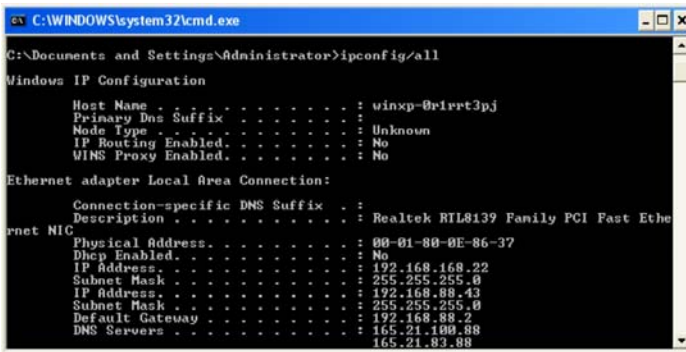

Your PC is now ready to configure your access point.

Step 7:

Launch your Web browser. Under the **Tools** tab, select **Internet Options**.



Step 8:

Open the **Connections** tab and in the **LAN Settings** section, disable all the option boxes. Click on the **OK** button to update the changes.

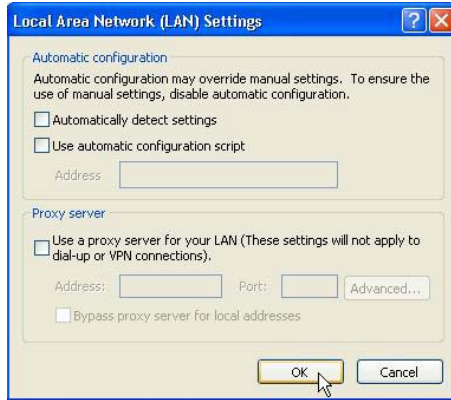

Step 9:

At the **Address** bar, enter `http://192.168.168.1` and press **Enter** on your keyboard.

Step 10:

At the login page, click on the **LOGIN!** button to enter the configuration pages.



You will then reach the home page of your access point's Web interface.

The screenshot shows a Microsoft Internet Explorer browser window titled "Wireless LAN Access Point (WP54AG) - Microsoft Internet Explorer". The address bar displays "http://192.168.55/en/main.asp". The main content area features the "COMPEX" logo and "NetPassage WP54AG" text. A navigation menu on the left is organized into three sections: "CONFIGURATION" with links for Management Port, WLAN Setup, STP Setup, SNMP Setup, Telnet/SSH Setup, and Web Server Setup; "SYSTEM TOOLS" with links for Ping Utility, Syslog, System Identity, Set System's Clock, Firmware Upgrade, Backup or Reset Settings, Reboot System, Change Password, and Logout; and "HELP" with links for Get Technical Support and About System. The central area displays "Wireless LAN Access Point (WP54AG)" in red, an image of the device, and the text "The current operation mode is Access Point". A footer message reads "# Welcome, please choose an option from the configuration menu." The browser's status bar at the bottom shows "Reboot the system" and "Internet".

Chapter 4: Common Configuration

This chapter illustrates the following features, which are available in ALL the operating modes of your access point, unless stated otherwise.

- [Management Port](#)
- [WLAN Basic Setup](#)
- [WLAN Security](#)
- [STP Setup](#)
- [SNMP](#)
- [MAC Filtering](#)
- [Antenna Alignment](#)

MANAGEMENT PORT SETUP

This section shows you how to customize the parameters of your access point to suit the needs of your network. It also explains how to make use of the built-in DHCP server of your access point.

SETTING UP YOUR LAN

You can opt to adjust the default values of your access point and customize them to your network settings.

Step 1:

Click on **Management Port** from the **CONFIGURATION** menu.

In the **Management Port Setup** page, refer to the table below to replace the default settings of Access point with appropriate values to suit the needs of your network.

Management Port Setup

IP Address:	<input type="text" value="192.168.168.1"/>
Network Mask:	<input type="text" value="255.255.255.0"/>
Management Gateway IP:	<input type="text"/>
DHCP Start IP Address:	<input type="text" value="192.168.168.100"/>
DHCP End IP Address:	<input type="text" value="192.168.168.254"/>
DHCP Gateway IP Address:	<input type="text" value="192.168.168."/>
DHCP Lease Time:	<input type="text" value="3600"/> (seconds)
<input type="checkbox"/> Always use these DNS servers	
Primary DNS IP Address:	<input type="text"/>
Secondary DNS IP Address:	<input type="text"/>
DHCP Server:	<input type="radio"/> Enable <input checked="" type="radio"/> Disable

Advanced DHCP Server Options

Step 2:

Click on the **Apply** button to save your new parameters.

This table describes the parameters that can be modified in the **Management Port Setup** page.

Parameters	Description
IP Address	<p>When the DHCP server of the access point is enabled (unless you set a different DHCP Gateway IP Address), this LAN IP Address would be allocated as the Default Gateway of the DHCP client.</p> <p>The IP address of your Access point is set by default to 192.168.168.1.</p>
Network Mask	<p>The Network Mask serves to identify the subnet in which your Access point resides. The default network mask is 255.255.255.0.</p>
Management Gateway IP	<p>(Optional) As a bridge Access Point, the access point does not usually communicate with devices on other IP subnets. However, the Management Gateway here acts as the equivalent of the Default Gateway of a PC, to allow the access point to communicate with devices on different subnets. For instance, if you want to access the access point from the Internet or from a router on the LAN, enter the router IP address in the Management Gateway IP field.</p> <p>The Management Gateway IP address of your access point is set to nil by default.</p>
<p>The next two fields (DHCP Start IP Address and DHCP End IP Address) allow you to define the range of IP addresses from which the DHCP Server can assign an IP address to the LAN.</p>	
DHCP Start IP Address	<p>This is the first IP address that the DHCP server will assign. The value that you input here should belong to the same subnet as your access point. For example, if the IP address and network mask of your access point are 192.168.168.1 and 255.255.255.0 respectively, the DHCP Start IP Address should be 192.168.168.X, where X can take any value from 2 to 254. It is pre-set to 192.168.168.100.</p>
DHCP End IP Address	<p>This is the last IP address that the DHCP server can assign. It should also belong to the same subnet as your access point. For instance, if the IP address and network mask of your access point are 192.168.168.1 and 255.255.255.0 respectively, the DHCP End IP Address should be 192.168.168.X, where X can take any value from 2 to 254. It is pre-set as 192.168.168.254.</p>

Parameters	Description
DHCP Gateway IP Address	<p>Though usually, the DHCP server also acts as the Default Gateway of the DHCP client, the access point gives you the option to define a different Gateway IP Address, which will be allocated as the Default Gateway IP of the DHCP client. The DHCP client will thus receive its dynamic IP address from the access point but will access to the Internet or to the other LAN through the Default Gateway defined by the DHCP Gateway IP Address.</p> <p>For instance, if the access point is used in Access Point Client mode and connects to an Internet gateway, X, a PC wired to the access point will be unable to obtain a dynamic IP address directly from X. But if you can enable the DHCP server of the access point and set the IP address of X as the DHCP Gateway IP Address, the PC will then obtain its IP address from the access point and access the Internet through X.</p>
Always use these DNS servers	Enable this checkbox if you want the access point to only use the DNS server(s) you have specified below.
Primary DNS IP Address	Your ISP usually provides the IP address of the DNS server.
Secondary DNS IP Address	This optional field is reserved for the IP address of a secondary DNS server.
DHCP Server	If you disable the DHCP server, you will need to manually configure the TCP/IP parameters of each computer in your network.

TO VIEW THE ACTIVE DHCP LEASES

The following will guide you to a page display of the active IP address leases that have been allocated by the built-in DHCP server of Access point.

Step 1:

Click on **Management Port** from the **CONFIGURATION** menu.

Step 2:

Go to the **Advanced DHCP Server Options** section, click on the **Show Active DHCP leases** button.

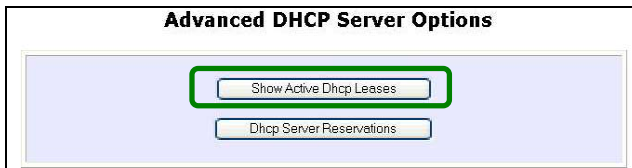

The **DHCP Active Leases** table displays:

- The **Host Name** of the DHCP client
- The **IP Address** that has been allocated to the DHCP client
- Its **Hardware (MAC) Address**
- The **Lease Expired Time**.

DHCP Active Leases

Host Name	IP Address	Hardware Address	Lease Expired Time
sampleHost	192.168.168.22	09-00-7c-01-00-01	11



NOTE

Invalid date and time displayed in the **Lease Expired Time** column indicates that the clock of your access point has not been properly set. Please refer to the **SYSTEM TOOLS** section for more details on how to set the system clock.

TO RESERVE SPECIFIC IP ADDRESSES FOR PREDETERMINED DHCP CLIENTS

Making an IP address reservation lets you inform the DHCP server to exclude that specific address from the pool of free IP addresses it draws on for dynamic IP address allocation.

For instance, if you set up a publicly accessible FTP/HTTP server within your private LAN, while that server would require a fixed IP address, you would still want the DHCP server to dynamically allocate IP addresses to the rest of the PCs on the LAN.

The following shows you how to reserve a particular IP address.

Step 1:

From the **Advanced DHCP Server** Options section, click on the **DHCP Server Reservations** button.

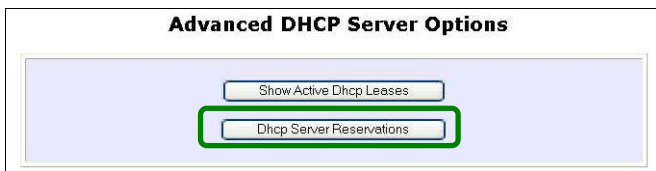

Step 2:

Click on **Add** button.



Step 3:

Fill in:

The host portion of the **IP Address** to reserve.

The **Hardware Address**, in pairs of two hex values

Press the **Apply** button to make your new entry effective.

DHCP Server Reservations

IP Address:

Hardware Address: (XX-XX-XX-XX-XX-XX)

The **DHCP Server Reservations** page will then be refreshed to illustrate the currently reserved IP addresses.

DHCP Server Reservations

IP Address	Hardware Address
192.168.168.20	00-80-45-e5-0d-05

DELETE DHCP SERVER RESERVATION

If you do not need the DHCP server to reserve an IP address anymore, you can delete the DHCP Server Reservation.

Step 1:

Click on the reserved IP address that you wish to delete, e.g. *192.168.168.20*.



The screenshot shows a table titled "DHCP Server Reservations". The table has two columns: "IP Address" and "Hardware Address". The first row contains the values "192.168.168.20" and "00-80-45-e5-0d-05". The "192.168.168.20" value is highlighted with a green box. Below the table are two buttons: "Add" and "Back".

IP Address	Hardware Address
192.168.168.20	00-80-45-e5-0d-05

Buttons: Add, Back

Step 2:

Click on the **Delete** button.



The screenshot shows the "DHCP Server Reservations" form. It has two input fields: "IP Address:" with the value "192.168.168.20" and "Hardware Address:" with the value "00-80-45-e5-0d-05" and a placeholder "(XX-XX-XX-XX-XX-XX)". Below the fields are three buttons: "Save", "Delete", and "Cancel". The "Delete" button is highlighted with a green box.

IP Address: 192.168.168.20
Hardware Address: 00-80-45-e5-0d-05 (XX-XX-XX-XX-XX-XX)

Buttons: Save, Delete, Cancel

The **DHCP Server Reservations** table will then be refreshed to reflect your changes.

WLAN SETUP

This section shows how to perform the following functions:

Basic:

This function performs a basic setup of the wireless modes of operation: **Access Point mode**, **Access Point Client mode** and other operating modes.

Security:

This function performs data encryption and protection for the access point.

Kindly refer to Chapter 5 on **WLAN Security** for details.

Advanced:

This function furthers the basic configuration of the access point by setting the system's additional parameters: **Wireless Pseudo VLAN**, **WDS Configuration** and **Long Distance Parameters**.

Kindly refer to Chapter 6 on **Wireless Extended Features** for details.

Statistics:

This function uses the **Scan Feature** to monitor and interpret the statistics data collected.

MAC Filtering (only applicable to Access Point mode):

MAC Filtering acts as a security measure by restricting the users accessing to the network through their MAC address.

Antenna Alignment:

It is a tool for aligning outdoor antenna between 2 access points over long distances. The signal level can be checked from the web page and also from the DIAG LED indicator.

TO CONFIGURE THE BASIC SETUP OF THE WIRELESS MODE

The following will guide you to configure the basic setup of the wireless mode you have selected.

Step 1:

Click on **WLAN Setup** from the **CONFIGURATION** menu. You will see the sub-menus expanded under **WLAN Setup**. Click on **Basic**.

The default operating mode of Access point is the **Access Point** mode.

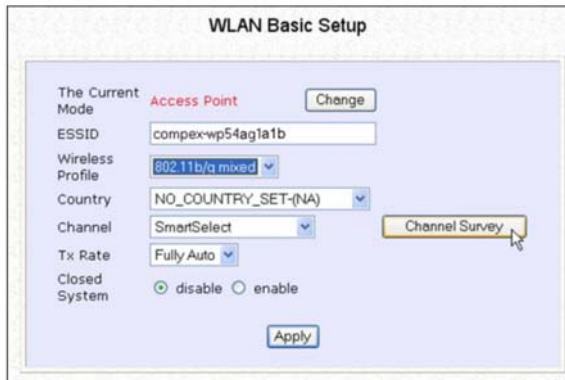

The screenshot shows the 'WLAN Basic Setup' configuration page. The current mode is 'Access Point'. The ESSID is 'compex-wp54ag1a1b'. The wireless profile is '802.11b/g mixed'. The country is 'NO_COUNTRY_SET-(NA)'. The channel is 'SmartSelect'. The Tx Rate is 'Fully Auto'. The Closed System is set to 'disable'. There is a 'Channel Survey' button and an 'Apply' button.

Field	Value
The Current Mode	Access Point
ESSID	compex-wp54ag1a1b
Wireless Profile	802.11b/g mixed
Country	NO_COUNTRY_SET-(NA)
Channel	SmartSelect
Tx Rate	Fully Auto
Closed System	<input checked="" type="radio"/> disable <input type="radio"/> enable

Step 2: (Optional: Change Current mode)

If you wish to change the current mode of your access point, click on **Change**, select your **Operation Mode** and click on the **Apply** button to access the setup page of your selected mode. Then you are prompted to reboot the access point so as to effect the mode setting.

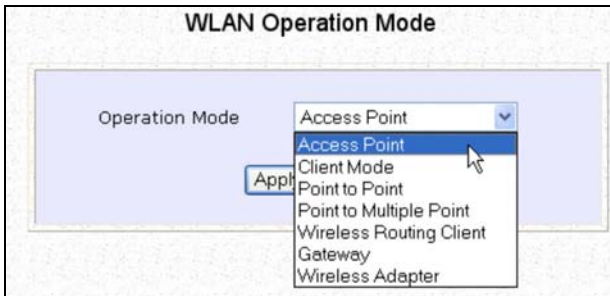

Step 3:

Enter the parameters in their respective fields, click on the **Apply** button and reboot your device to let your changes take effect.

Note that the **WLAN Basic Setup** page for the **Client** mode is different from that of the **Access Point** mode.

The screenshot shows the 'WLAN Basic Setup' interface for Client Mode. At the top, it says 'The Current Mode Client Mode' with a 'Change' button. Below this are several configuration fields: 'ESSID' with the value 'compex-wp54ag1a1b' and a 'Site Survey' button; 'Wireless Profile' set to '802.11b/g mixed'; 'Country' set to 'NO_COUNTRY_SET-(NA)'; and 'Tx Rate' set to 'Fully Auto'. An 'Apply' button is located at the bottom of the configuration area. Below the configuration area is a 'Link Information' section with a 'Show Link Information' button.

If you wish to set the access point in the **Point-to-Point** mode, click on **Change** to select **Point to Point**, and then you will see the page below.

The screenshot shows the 'WLAN Basic Setup' interface for Point-to-Point mode. At the top, it says 'The Current Mode Point to Point' with a 'Change' button. Below this are several configuration fields: 'ESSID' with the value 'compex-wp54ag1a1b'; 'Wireless Profile' set to '802.11b/g mixed'; 'Peer MAC' with an empty field and a placeholder '(XX-XX-XX-XX-XX-XX)'; 'Country' set to 'NO_COUNTRY_SET-(NA)'; 'Channel' set to 'SmartSelect'; and 'Tx Rate' set to 'Fully Auto'. An 'Apply' button is located at the bottom of the configuration area.

If you wish to set the access point in the **Point to Multiple Point** mode, click on **Change** to select **Point to Multiple Point**, and then you will see the page below.

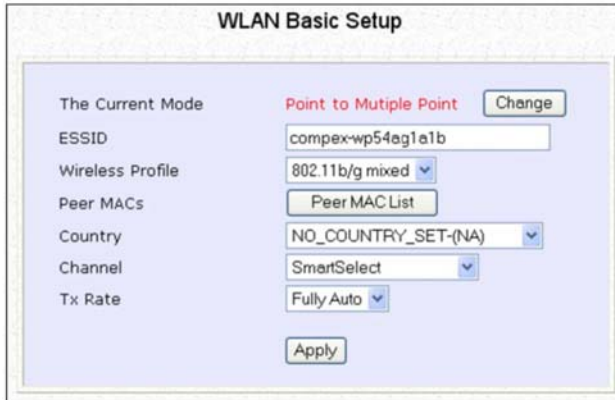

The image shows a screenshot of the 'WLAN Basic Setup' configuration page. The title is 'WLAN Basic Setup'. Below the title, there is a section for 'The Current Mode' which is set to 'Point to Multiple Point' with a 'Change' button next to it. Below this, there are several configuration options: 'ESSID' is 'compex-wp54ag1a1b', 'Wireless Profile' is '802.11b/g mixed', 'Peer MACs' has a 'Peer MAC List' button, 'Country' is 'NO_COUNTRY_SET-(NA)', 'Channel' is 'SmartSelect', and 'Tx Rate' is 'Fully Auto'. At the bottom of the configuration area is an 'Apply' button.

To create a new peer MAC, click on the **Peer MAC List** button. The page will appear. (Please take note that **PtMP** stands for **Point to Multiple Point**).



The image shows a screenshot of the 'PtMP Configuration' page. The title is 'PtMP Configuration'. Below the title, there is a table with three columns: 'Link No.', 'Hardware Address', and 'Comments'. Below the table is an 'Add' button.

Click on **Add**, and then you are prompted to key in **Hardware Address** and **Comment**.



The image shows a screenshot of the 'Add WDS Entry' dialog box. The title is 'Add WDS Entry'. Below the title, there are two input fields: 'Hardware Address' and 'Comment'. The 'Hardware Address' field has a placeholder '(XX-XX-XX-XX-XX-XX)'. Below the input fields are 'Add' and 'Cancel' buttons.

This table describes the parameters that can be modified in the [WLAN Basic Setup](#) page.

Parameters	Description
The Current Mode	<p>The default operating mode of the access point is the Access Point mode. The access point can operate in 6 modes:</p> <ul style="list-style-type: none"> • Access Point • Client • Point to Point • Point to Multiple Point • Wireless Routing Client • Gateway • Wireless Adapter <p>You can toggle the mode by clicking on the Change button.</p>
ESSID	<p>Enter a preferred name for the wireless network. Your wireless clients must be configured with the same ESSID.</p> <p>This case-sensitive entry can consist of a maximum of 32 characters.</p>
Site Survey	<p>A list of wireless devices that are detected by your access point in the WLAN. Information such as MAC address, channel, SSID, algorithm and signal strength can be found in the listing.</p> <p>This feature is supported by the Access Point Client and Wireless Routing Client modes.</p>
Wireless Profile	<p>A selection of network environment types in which to operate the access point:</p> <ul style="list-style-type: none"> • 802.11a only This mode supports wireless A clients with data rates of up to 54Mbps in the frequency range of 5.4GHz. • 802.11b only This mode supports wireless B clients with data rates of up to 11Mbps in the frequency range of 2.4GHz.

	<ul style="list-style-type: none"> • 802.11b/g mixed This mode supports both wireless B and G clients. • 802.11g only This mode supports wireless-G clients that offer transmission rates of up to 54Mbps in the 2.4GHz frequency band.
Peer Mac (Only in Point-to-Point mode)	This mode can support more than one access point. This feature allows you to create a new peer MAC for another access point so that the router operating in the access point mode can connect to another access point.
Peer MACs (Only in Point-to-Multiple Point mode)	This mode can support multiple access points. This feature allows you to create multiple peer MAC addresses so that the router can connect to multiple access points.
Country	Choose the Country where you are located.
Channel	<p>This option allows you to select a frequency channel for the wireless communication. This parameter is only available in the Access Point, Point to Point and Point to Multiple Point modes.</p> <p>Select SmartSelect to automatically scan and recommend the best channel that the access point can utilize.</p>
Tx Rate	Allow you to choose the rate of data transmission from 1Mbps to Fully Auto .
Closed System	The access point will not broadcast its WLAN name (ESSID) when Closed system is enabled. By default Closed system is disabled.
Channel Survey	A list of channels that are detected by your access point in the WLAN. Information such as frequency, channel, MyQuality, NeighQuality, APCount and Recommendation can be found in the listing. The Access Point and Gateway modes support this feature.

SCAN FOR SITE SURVEY (ONLY FOR CLIENT MODE AND WIRELESS ROUTING CLIENT MODE)

Step 1:

In the **Mode Setup** page, click on the **Site Survey** button.



The image shows the 'WLAN Basic Setup' configuration page. At the top, it says 'The Current Mode Client Mode' with a 'Change' button. Below this are several configuration fields: 'ESSID' with the value 'complex-wp54ag1a1b', 'Wireless Profile' set to '802.11b/g mixed', 'Country' set to 'NO_COUNTRY_SET-(NA)', and 'Tx Rate' set to 'Fully Auto'. A 'Site Survey' button is highlighted with a green box. At the bottom of the configuration area is an 'Apply' button. Below the configuration area is a section titled 'Link Information' with a 'Show Link Information' button.

The **Site Survey** provides a list of the **MAC addresses (BSSID)** and **SSID** of neighbouring access points detected, the **Chan** (channels), **Auth** (Authentication), **Alg** (Algorithm) used, and the strength of the **Signal** received.



The image shows the 'Site Survey' results page. It contains a table with the following columns: Bssid, SSID, Chan, Auth, Alg, and Signal. Each row represents a detected access point and includes a radio button for selection. At the bottom of the table is an 'Apply' button. Below the table are 'Refresh' and 'Back' buttons.

Bssid	SSID	Chan	Auth	Alg	Signal
<input type="radio"/> 008048003472	PMD-28G-Online	6	WPA-PSK	TKIP	8
<input type="radio"/> 008048015403	wp54-1C	1	RSN-PSK	AES	3
<input type="radio"/> 00804830b5bd	wpe-A	6	WPA-PSK	TKIP	3
<input type="radio"/> 00804821f877	np18a-tang	10	WPA-EAP	TKIP	2
<input type="radio"/> 00804835891e		10	OPEN	NONE	22
<input type="radio"/> 00804800348d	OMEGA1	8	OPEN	NONE	9
<input type="radio"/> 00804800345d	complex-np28g-with-supergg-supergg	7	OPEN	NONE	5
<input type="radio"/> 00804824c675	Any	3	OPEN	NONE	3
<input type="radio"/> 008048358861	complex-np28g	6	OPEN	NONE	7

Step 2:

To connect the WP54AG-client to one of the access points detected:
Select the radio button corresponding to the access point you want to connect to.

Step 3:

Click on the **Apply** button to effect the change and return to the setup page.

Step 4:

Click on the **Refresh** button to update this screen.

This table describes the read-only parameters of neighbouring access points that can be viewed from the **Site Survey** page.

Parameters	Description
Bssid	In an infrastructure wireless network, the BSSID refers to the wireless MAC address of the access point.
SSID	Refers to the network name that uniquely identifies the network to which the access point is connected.
Chan	Refers to the channel being used for transmission.
Auth	Refers to the types of authentication, such as WPA, WPA-Personal, etc being used by the access point.
Alg	Refers to the types of algorithm, such as WEP, TKIP, etc being used by the access point.
Signal	Describes the strength of the signal received in percentage.



NOTE

The purpose of using **Site Survey** is to scan and display all access points based on the current security setting of your access point. For instance, the following information supplied by the Site Survey according to the security setting is explained:

- If the security mode is set to **None** or **WEP**, the scan will show all available access points that have no security or WEP security
 - If the security mode is set to **WPA-Personal**, the scan will show all available access points having all types of security from **no** security, **WEP** security to **WPA-Personal** security.
-

SHOW LINK INFORMATION (ONLY FOR CLIENT MODE AND WIRELESS ROUTING CLIENT MODE)

Step 1:

To view the connection status when WP54AG-client is linked to another access point, click on the **Show Link Information** button.



The screenshot shows the 'WLAN Basic Setup' interface. It includes fields for 'The Current Mode' (Client Mode), 'ESSID' (complex-wp54ag1a1b), 'Wireless Profile' (802.11b/g mixed), 'Country' (NO_COUNTRY_SET-(NA)), and 'Tx Rate' (Fully Auto). Below these fields is an 'Apply' button. At the bottom of the page, the 'Link Information' section is highlighted with a green box, containing a 'Show Link Information' button.

The **Link Information** table illustrates the following data:

Link Information	
State	Scanning: ff: ff: ff: ff: ff: ff
Current Channel	11
TxRate	1Mbps
Signal Strength	6

This table describes the parameters that can be viewed from the **Link Information** page.

Parameters	Description
State	Refers to the MAC address of the BSS (AP to which the WP54AG-client is connected).
Current Channel	The channel that is being presently used for transmission.
Tx Rate	The rate of data transmission in Mbps.
Signal Strength	Given in percentage, showing the intensity of the signal received.

SCAN FOR CHANNEL SURVEY (AVAILABLE FOR ACCESS POINT MODE AND GATEWAY MODE)

Channel Survey provides a list of all channels that are supported by the access point. This feature will show relative interference of all channels and recommend the least congested channel.

When the users want to scan for and find the best channel, they can use **Channel Survey**.

Step 1:

In the **Mode Setup** page, click on the **Channel Survey** button.



The **Channel Survey** provides a list of the **Freq** (frequency) and **Channel** of the access point detected, the **APCount**, **MyQuality** (your access point's interference from your access point's channel signal) received and **NeighQuality** (interference from the neighbouring access points' channel signals) received.

Channel Survey Status						
	Freq	Channel	MyQuality	APCount	NeighQuality	Recommendation
<input type="radio"/>	2437	6	0	0	28	
<input type="radio"/>	2447	8	0	0	23	
<input type="radio"/>	2452	9	0	0	9	
<input type="radio"/>	2462	11	0	0	9	Recommended
<input type="radio"/>	2417	2	4	2	130	
<input type="radio"/>	2432	5	5	1	194	
<input checked="" type="radio"/>	2457	10	9	1	0	
<input type="radio"/>	2412	1	23	2	4	
<input type="radio"/>	2442	7	23	1	0	
<input type="radio"/>	2422	3	107	3	198	
<input type="radio"/>	2427	4	194	5	112	

The values indicate the level of interference.
 The higher the value, the higher the interference.
 If the value is zero, there is no interference.

Step 5:

To connect the WP54AG-client to one of the channels detected, select the radio button corresponding to the channel you want to connect to.

Step 6:

Click on the **Apply** button to effect the change and return to the setup page.

Step 7:

Click on the **Refresh** button to update this screen.

This table describes the read-only parameters of all channels that can be viewed from the **Channel Survey** page.

Parameters	Description
Freq	Refers to the frequency of the channel at which your access point is operating.
Channel	Refers to the channel of the access point being used for transmission depending on its origin of country.
MyQuality	Indicates the interference level of the respective channel with this AP. The lower the value, the less interference.
APCount	Refers to the total number of access points operating at the current channel.
NeighQuality	Indicates the interference level with those discovered APs at those respective channels. The lower the value, the less interference.
Recommendation	Indicates the best channel for the AP device to use in its current environment.

ANTENNA ALIGNMENT (AVAILABLE FOR ALL MODES)

The **Antenna Alignment** feature in the access point is designed to precisely align the antenna over such a long distance so that the connectivity communication between your access point and another remote or neighbouring access point could be improved as indicated by higher signal strength.

Step 1:

Click on **WLAN Setup** from the **CONFIGURATION** menu. You will see the sub-menu expanded under **WLAN Setup**. Click on **Antenna Alignment**. The **Antenna Alignment** page can act as a diagnostic tool to check the communication with a remote device. The remote AP MAC Address is preset to all zeros by default.

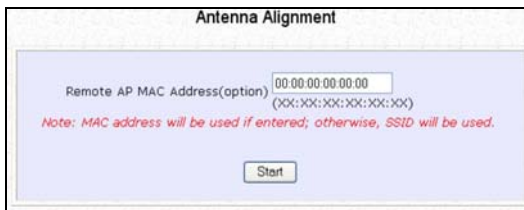

Antenna Alignment

Remote AP MAC Address(option) 00:00:00:00:00:00
(XX:XX:XX:XX:XX:XX)

Note: MAC address will be used if entered; otherwise, SSID will be used.

Start

Step 2:

If you wish to specify the MAC address of the remote AP, key in the field next to **Remote AP Address (option)**, followed by executing the **Start** button. Then the pop-up status screen will show up, allowing you to monitor the signal strength received from the remote access points.

If there is no specified AP with its MAC address you have keyed in, the screen below will show on the right. To abort or key in the MAC address of the other available remote AP, click on the **Stop** button.

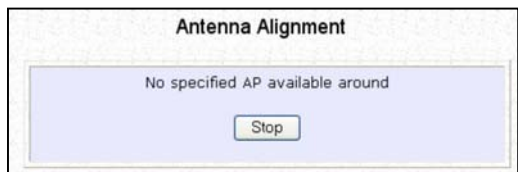

Antenna Alignment

No specified AP available around

Stop



NOTE

If no MAC address is entered, the **Antenna Alignment** tool will make use of the SSID to align the antenna. Please make sure that the correct SSID is entered. If more than one access point (AP) share the same SSID, the **Antenna Alignment** tool will show the strongest signal AP.

The DIAG LED indicates the signal strength as described below:

Signal Strength (RSSI Value)	Status of DIAG LED
Above 20	Stays turned ON
Between 19 and 17	Flashes 6 times
Between 17 and 14	Flashes 3 times
Between 13 and 10	Flashes ONCE
Below 10	Turns OFF



NOTE

The signal strength of below RSSI of 10 is not recommended for outdoor long distance connection.



NOTE: To ensure proper functionality of the device, select to Stop after performing antenna alignment. Alternatively, you may also reboot the device.

TO CONFIGURE THE SECURITY SETUP OF THE WIRELESS MODE

Kindly refer to Chapter 5 on **WLAN Security** for details on setting the different security modes of the access point.

TO CONFIGURE THE ADVANCED SETUP OF THE WIRELESS MODE

The following will guide you to configure the advanced setup of the wireless mode you have selected.

Step 1:

Click on **WLAN Setup** from the **CONFIGURATION** menu to expand into the four sub-menus. From here, click on **Advanced**.

Step 2:

In the **WLAN Advanced Setup** page, enter the parameters.

Step 3:

Click on the **Apply** button to update the changes.

WLAN Advanced Setup

Beacon Interval	<input type="text" value="100"/>	(100:20-1000)
Data Beacon Rate (DTIM)	<input type="text" value="1"/>	(1:1-16384)
RTS/CTS Threshold	<input type="text" value="2312"/>	(2312:1-2312)
Frag Threshold	<input type="text" value="2346"/>	(2346:256-2346)
Transmit Power	<input type="button" value="Maximum"/>	
Radio Off When Ethernet Link Down	<input type="checkbox"/>	
Antenna Control	<input type="button" value="Auto"/>	

Extended Features

This table describes the parameters that can be modified in the [WLAN Advanced Setup](#) page.

Parameters	Description
Beacon Interval (Only in Access Point mode)	<p>The Beacon Interval is the amount of time between beacon transmissions. A beacon is a guidance signal sent by the access point to announce its presence to other devices in the network.</p> <p>Before a client enters the power-save mode, it needs the <i>beacon interval</i> to know when to wake up to receive the beacon (and learn whether there are buffered frames at the access point).</p>
Data Beacon Rate (DTIM) (Only in Access Point mode)	<p>The Data Beacon Rate (DTIM) determines how often the beacon contains a delivery traffic indication message (DTIM). The DTIM identifies which clients (in power-save mode) have data frames waiting for them in the access point's buffer.</p> <p>If the beacon period is set at 100 (default value), and the data beacon rate is set at 1 (default value), then the access point sends a beacon containing a DTIM every 100 Kμsecs (1 Kμsec equals 1,024 μsec).</p>
RTS/CTS Threshold	<p>The RTS/CTS Threshold value determines the minimum size of a packet in bytes that would trigger the RTS/CTS mechanism.</p>
Frag Threshold	<p>The Frag Threshold value indicates the maximum size that a packet can reach without being fragmented.</p> <p>This value extends from 256 to 2346 bytes, where a value of 0 indicates that all the packets should be transmitted using RTS.</p>
Transmit Power	<p>The Transmit Power drop-down list lets you pick from a range of transmission power.</p>
Radio Off When Ethernet Link Down	<p>The Radio Off When Ethernet Link Down function detects when the Ethernet link is down and disables the radio card automatically.</p>

Antenna Control	<p>The Antenna Control function allows you to control whether to use the:</p> <ul style="list-style-type: none"> • Main antenna • Aux (auxiliary) antenna • Auto (Default), to monitor the signal from each antenna and automatically switch to the one with better signal
------------------------	---



NOTE

The values illustrated in the examples are suggested values for their respective parameters.

STATISTICS

The following shows you the information on the wireless device that is connected to the WLAN.

IN ACCESS POINT MODE

Step 1:

Click on **WLAN Setup** from the **CONFIGURATION** menu. You will see the sub-menus expanded under **WLAN Setup**. Click on **Statistics**.

Wireless clients that are connected to the WLAN are shown in the WLAN Station List.

Step 2:

Click on the **Refresh** button to get the latest information on the availability of wireless clients in the wireless network.

WLAN Station List			
ID	MAC Address	RSSI	TxRate
AP	00:80:48:37:86:dd	1	36Mbps

Step 3:

To check the details on individual wireless client, click on the MAC Address in the WLAN Station List.

The following screen will show the statistics of the selected wireless client.

00:80:48:37:86:dd Statistics						
Authentication Type			Encryption			
Open-System			No			
Authentication	Deauthentication	Association	Disassociation	Reassociation		
0	0	0	0	0		
	MSDU	Data	Multicast	Management	Control	Errors
Receive	0	0	0	2122	0	0
Transmit	0	0	0	11	0	0

[Back](#)

IN CLIENT MODE

Click on **WLAN Setup** from the **CONFIGURATION** menu. You will see the sub-menus expanded under **WLAN Setup**. Click on **Statistics**.

00:80:48:37:86:dd Statistics						
Authentication Type			Encryption			
Open-System			No			
Authentication	Deauthentication	Association	Disassociation	Reassociation		
0	0	0	0	0		
	MSDU	Data	Multicast	Management	Control	Errors
Receive	0	0	0	2122	0	0
Transmit	0	0	0	11	0	0
<input type="button" value="Back"/>						

In **Client** mode, you are not allowed to view other wireless clients' statistics. To view other wireless clients information, you need to change to Access Point mode.

IN POINT TO POINT MODE

Click on **WLAN Setup** from the **CONFIGURATION** menu. You will see the sub-menus expanded under **WLAN Setup**. Click on **Statistics**.

00:80:48:02:56:0d Statistics						
Authentication Type			Encryption			
Open-System			No			
Authentication	Deauthentication	Association	Disassociation	Reassociation		
0	0	0	0	0		
	MSDU	Data	Multicast	Management	Control	Errors
Receive	0	0	0	0	0	26
Transmit	90	90	0	1	0	0
<input type="button" value="Back"/>						

IN POINT TO MULTIPLE POINT MODE

Click on **WLAN Setup** from the **CONFIGURATION** menu. You will see the sub-menus expanded under **WLAN Setup**. Click on **Statistics**.

00:80:48:37:86:dd Statistics						
Authentication Type			Encryption			
Open-System			No			
Authentication	Deauthentication	Association	Disassociation	Reassociation		
0	0	0	0	0		
	MSDU	Data	Multicast	Management	Control	Errors
Receive	0	0	0	2122	0	0
Transmit	0	0	0	11	0	0
<input type="button" value="Back"/>						

IN WIRELESS ROUTING CLIENT MODE

Click on **WLAN Setup** from the **CONFIGURATION** menu. You will see the sub-menus expanded under **WLAN Setup**. Click on **Statistics**.

00:80:48:37:91:9d Statistics						
Authentication Type			Encryption			
Open-System			No			
Authentication	Deauthentication	Association	Disassociation	Reassociation		
0	0	0	0	0		
	MSDU	Data	Multicast	Management	Control	Errors
Receive	0	0	0	1056	0	0
Transmit	0	0	0	12	0	0
<input type="button" value="Back"/>						

IN GATEWAY MODE

Click on **WLAN Setup** from the **CONFIGURATION** menu. You will see the sub-menus expanded under **WLAN Setup**. Click on **Statistics**.

00:80:48:37:91:9d Statistics						
Authentication Type			Encryption			
Open-System			No			
Authentication	Deauthentication	Association	Disassociation	Reassociation		
0	0	0	0	0		
	MSDU	Data	Multicast	Management	Control	Errors
Receive	0	0	0	1056	0	0
Transmit	0	0	0	12	0	0
<input type="button" value="Back"/>						

To view the statistics information if a wireless client connected to the AP, click on the MAC address of that client.

WAN SETUP

(only supported by Wireless Routing Client and Gateway)

A correct **WAN Setup** allows you to successfully share your Internet connection among the wired and wireless clients of the access point. To do so, you need to identify the type of broadband Internet access you are subscribed to. If you are using :

- *Cable Internet where the ISP dynamically assigns a WAN IP address* to you, refer to WAN Setup - Cable Internet with Dynamic IP Assignment.
- *Cable Internet where your ISP provides you with a fixed WAN IP address* (or a range of fixed IP addresses), refer to WAN Setup - Cable Internet with Static IP Assignment.
- *ADSL Internet that requires standard PPP over Ethernet (PPPoE)* for authentication, refer to WAN Setup - ADSL Internet using PPP over Ethernet (PPPoE).
- *ADSL Internet that requires standard Point-to-Point Tunneling Protocol (PPTP)* for authentication, refer to WAN Setup - ADSL Internet using Point-to-Point Tunneling Protocol (PPTP).

WAN Setup - Cable Internet with Dynamic IP Assignment

The access point is pre-configured to support a WAN type that dynamically obtains an IP address from the ISP. However, you may verify the WAN settings with the following steps:

Step 1: Under **CONFIGURATION** on the command menu, click on **WAN Setup**.

Step 2:

On the **WAN Dynamic Setup** screen that follows, verify that the **WAN Type** reads **Dynamic (DHCP)** in red colour. Otherwise, click on the **Change** button.

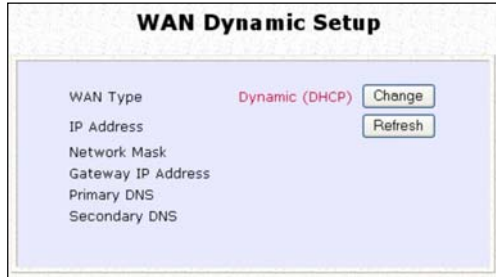

Step 3:

Simply select **Dynamic IP Address** and hit the **Apply** button.

Please remember to click **Reboot System** under **SYSTEM TOOLS** and hit the **Reboot** button to let the settings take effect.

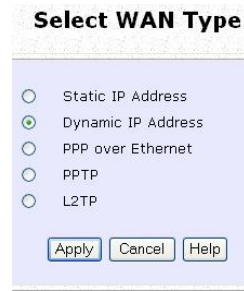

Note:

Additional configuration might be required before your ISP will allocate an IP address to the access point.

Certain ISPs require authentication through a DHCP Client ID before releasing a public IP address to you. The access point uses the System Name in the System Identity as the DHCP Client ID.

Therefore, if this is the case, refer to your ISP for the correct DHCP Client ID to be set and follow **steps 4 - 5** to accomplish the setup.

Step 4:

Steps 4 - 5 are for those who need to set up the **System Name** in **System Identity** so that your ISP can authenticate it as a valid DHCP Client ID.

Click on **System Identity** under the **SYSTEM TOOLS** command menu.

Step 5:

On the following screen, key in the your ISP assigned DHCP Client ID as the **System Name** (You may also like to key in a preferred **Systems Contact** person and the **System Location** of the access point). Click the **Apply** button to complete.

Please remember to click **Reboot System** under **SYSTEM TOOLS** and hit the **Reboot** button to let the settings take effect.



The screenshot shows a web interface titled "System Identity". It contains three input fields: "System Name" with the value "Wireless LAN Access Point", "System Contact" with the value "unknown", and "System Location" with the value "unknown". Below these fields is an "Apply" button.

System Identity	
System Name :	Wireless LAN Access Point
System Contact :	unknown
System Location :	unknown
<input type="button" value="Apply"/>	

WAN Setup - Cable Internet with Static IP Assignment

If you have an ISP that leases a static WAN IP for your subscription, you will need to configure your access point's WAN type accordingly. For example, if the ISP provided you with the following setup information, you can set up your WAN as described below:

IP Address : 203.120.12.240
Network Mask : 255.255.255.0
Gateway IP Address : 203.120.12.2

Step 1:

Under **CONFIGURATION** on the command menu, click on **WAN Setup**.

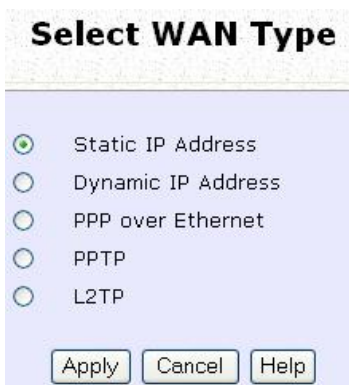

Select WAN Type

Static IP Address
 Dynamic IP Address
 PPP over Ethernet
 PPTP
 L2TP

Apply Cancel Help

Step 2:

Access the **Select WAN Type** page and choose **Static IP Address** before clicking the **Apply** button. You will then be brought to the following page requiring your inputs.

Step 3:

Fill in the information provided by your ISP in the **IP Address**, **Network Mask** and **Gateway IP Address** fields, before clicking the **Apply** button.

Please remember to click **Reboot System** under **SYSTEM TOOLS** and hit the **Reboot** button to let the settings take effect.



WAN Static Setup

WAN Type: Static Change

IP Address: 203.120.12.240

Network Mask: 255.255.255.0

Gateway IP Address: 203.120.12.2

Apply Help

WAN Setup - ADSL Internet using PPP over Ethernet (PPPoE)

If you subscribe to an ADSL service using PPP over Ethernet (PPPoE) authentication, you can set up your access point's WAN type as follows. For example, you may configure an account whose username is 'guest' as described below:

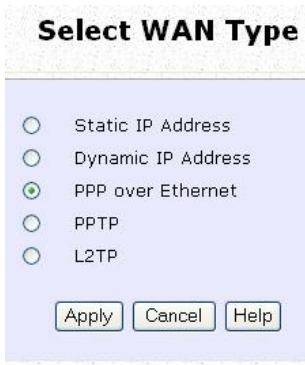

Step 1:

Under **CONFIGURATION** on the command menu, click on **WAN Setup**.

Step 2:

Access the **Select WAN Type** page and choose **PPP over Ethernet** before clicking the **Apply** button. You will then be brought to the following page requiring your inputs.

Step 3:

For **Username**, key in your ISP assigned account name (e.g. guest for this example), followed by your account **Password**.

Step 4:

Select **Always-On** if you want your access point to always maintain a connection with the ISP. Otherwise, you may select **On-Demand**. The access point will then connect to the ISP automatically when it receives Internet requests from the PCs in your network.

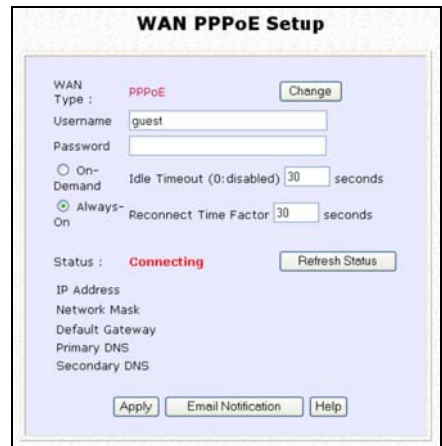

The **Idle Timeout** setting is associated with the **On-Demand** option, allowing you to specify the value (in seconds) after which the access point will disconnect from the ISP after the last Internet activity. A value of "0" will disable idle timeout. **Reconnect Time Factor** is associated with the **Always-on** option and specifies the maximum time the access point will wait before re-attempting to connect with your ISP. Hit the **Apply** button and **Reboot** the access point.

You can limit the maximum size a packet can be in a network by setting the **MTU** (Maximum Transmissible Unit).

Click the **MTU** Button in **Advanced WAN Options**.

Advanced WAN Options



The **MTU Value** has a range of 1 to 1492.

Enter the **MTU Value** and click **Apply**.

MTU Setup

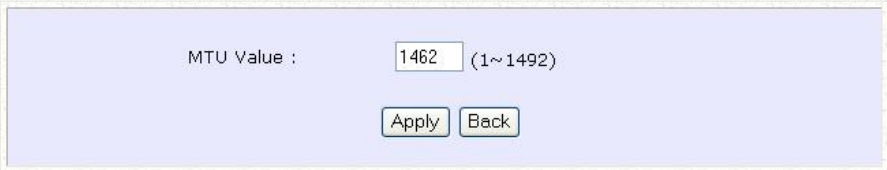
A screenshot of a web form titled "MTU Setup". The form contains a label "MTU Value :" followed by a text input field containing the number "1462". To the right of the input field is the text "(1~1492)". Below the input field are two buttons: "Apply" and "Back".

WAN Setup – ADSL Internet using PPTP

If you subscribe to an ADSL service using Point-to-Point Tunneling Protocol (PPTP) authentication, you can set up your access point's WAN type from the steps that follow. For example, if the ISP provided you with the following set up information, you can set up your WAN as described below:

IP Address : 203.120.12.47
Network Mask : 255.255.255.0
VPN Server : 203.120.12.15

Step 1:

Under **CONFIGURATION** on the command menu, click on **WAN Setup**.

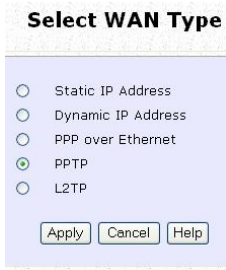

Select WAN Type

Static IP Address
 Dynamic IP Address
 PPP over Ethernet
 PPTP
 L2TP

Apply Cancel Help

Step 2:

Access the **Select WAN Type** page and choose **PPTP** before clicking the **Apply** button. You will then be brought to the following page requiring your inputs.

Step 3:

Fill in the information provided by your ISP in the **IP Address**, **Network Mask**, **VPN Server**, and **DHCP** fields, followed by clicking the **Apply** button.

Please remember to click **Reboot System** under **SYSTEM TOOLS** and hit the **Reboot** button to let the settings take effect.

The **Idle Timeout** setting allows you to specify the value (in seconds) after which the access point will disconnect from the ISP after the last Internet activity. A value of "0" will disable idle timeout.

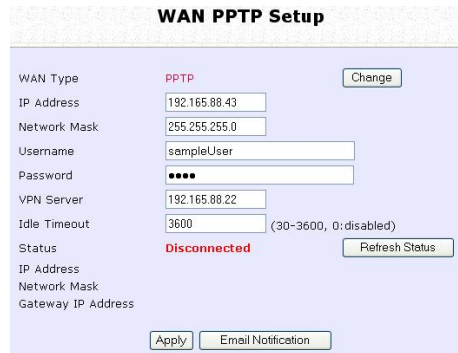

WAN PPTP Setup

WAN Type: PPTP (Change)

IP Address: 192.165.88.43

Network Mask: 255.255.255.0

Username: sampleUser

Password: ****

VPN Server: 192.165.88.22

Idle Timeout: 3600 (30-3600, 0:disabled)

Status: Disconnected (Refresh Status)

IP Address, Network Mask, Gateway IP Address

Apply Email Notification

WAN Setup – L2TP

If you're using Layer 2 Tunneling Protocol (L2TP) authentication, you can set up your access point's WAN type from the steps that follow. For example, if the ISP provided you with the following set up information, you can set up your WAN as described below:

IP Address : 203.120.12.47
Network Mask : 255.255.255.0
VPN Server : 203.120.12.15

Step 1:

Under **CONFIGURATION** on the command menu, click on **WAN Setup**.



Select WAN Type

Static IP Address
 Dynamic IP Address
 PPP over Ethernet
 PPTP
 L2TP

Step 2:

Access the **Select WAN Type** page and choose **L2TP** before clicking the **Apply** button. You will then be brought to the following page requiring your inputs.

Step 3:

Fill in the information provided by your ISP in the **IP Address**, **Network Mask**, **VPN Server**, and **DHCP** fields, followed by clicking the **Apply** button.

Please remember to click **Reboot System** under **SYSTEM TOOLS** and hit the **Reboot** button to let the settings take effect.

The **Idle Timeout** setting allows you to specify the value (in seconds) after which the access point will disconnect from the ISP after the last Internet activity. A value of "0" will disable idle timeout.



WAN L2TP Setup

WAN Type: **L2tp**

IP Address:

Network Mask:

Gateway:

Username:

Password:

VPN Server:

Idle Timeout: (30-3600, 0: disabled)

Status: **Disconnected**

IP Address:

Network Mask:

Gateway IP Address:

TELNET/SSH SETUP

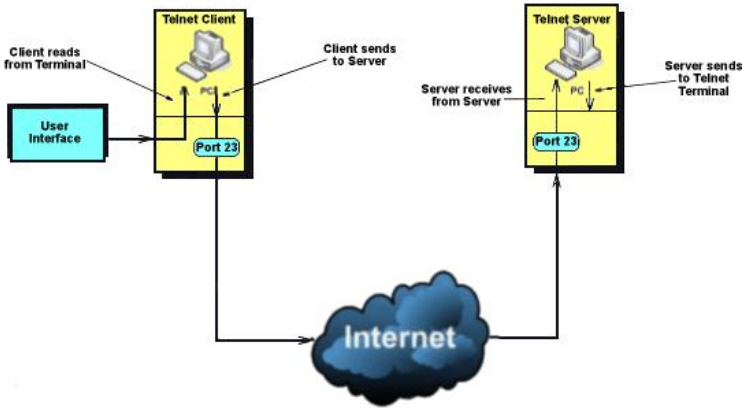

Telnet allows a computer to remotely connect to the WP54AG CLI (Command Line Interface) for control and monitoring.

SSH (Secure Shell Host) establishes a secure host connection to the WP54AG CLI for control and monitoring.

Telnet/SSH Setup

1

Click [Telnet/SSH Setup](#) from the **CONFIGURATION** menu.

2

1. To enable Telnet Server: Select Telnet Server Enable and enter the Port Number.
2. To enable SSH server: Select SSH Server Enable and enter the Port Number.

Click [Apply](#).

Telnet/SSH Setup

<input type="checkbox"/> Telnet Server Enable	Port Number	<input type="text" value="23"/>
<input type="checkbox"/> SSH Server Enable	Port Number	<input type="text" value="22"/>

3

To add user:

1. Click Add button.

User Management

Select	User Name	Permission
<input type="button" value="Add"/> <input type="button" value="Delete"/> <input type="button" value="Refresh"/>		

2. In Add User Entry Page, enter User Name, Password, and specify whether user is granted permission to Read Only or Read/Write.

3. Click Apply.

Add User Entry

User Name	<input type="text"/>
Password	<input type="text"/>
Permission	<input type="text" value="Read Only"/> ▼

To Delete User:

1. Select which user to Delete.
2. Click Delete.

User Management

Select	User Name	Permission
<input checked="" type="checkbox"/>	username	RO
<input type="checkbox"/>	username2	RW

User Management list refreshes to update users.

To Refresh User Management list:

Click Refresh to refresh User Management list.

User Management

Select	User Name	Permission
<input type="checkbox"/>	username2	RW

TELNET COMMAND LINE INTERFACE

Telnet CLI (Command Line Interface)

The user may connect to the CLI (Command Line Interface) via a TELNET session to the default IP, **192.168.168.1**. This section uses Microsoft TELNET command for instruction. You may use any TELNET client.

Connecting to CLI (Command Line Interface) via TELNET

1. Connect to CLI (Command Line Interface) with the following command at DOS prompt. The TELNET application will then be launched and connect.

C:\WINDOWS\TELNET 192.168.168.1

2. At the login prompt, type in “password” (default password) and press the <ENTER> key, as shown in Figure 2.4c. You will then login to the CLI.

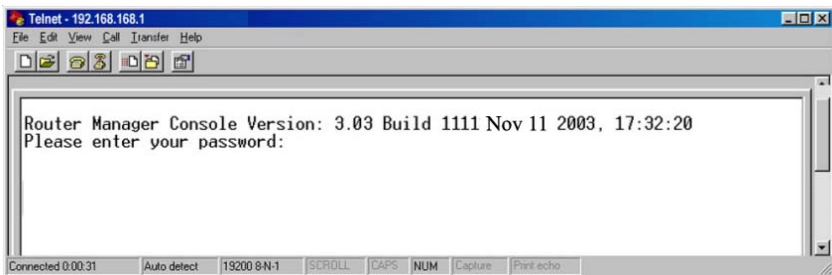

SECURE SHELL HOST COMMAND LINE INTERFACE

SSH CLI (Secure Shell Host Command Line Interface)

SSH is designed and created to provide the best security when accessing another computer remotely. Not only does it encrypt the session, it also provides better authentication facilities and features that increase the security of other protocols. It can use different forms of encryption and ciphers.

The first diagram below shows a telnet session.

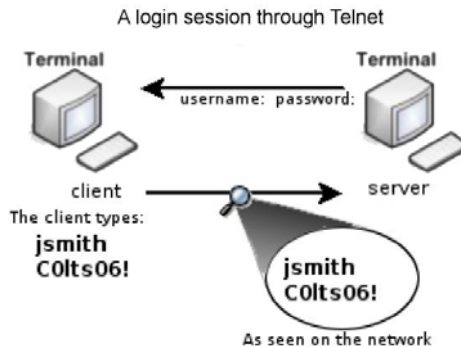

The second diagram below shows how an encrypted connection like SSH is not viewable on the network. The server still can read the information, but only after negotiating the encrypted session with the client.

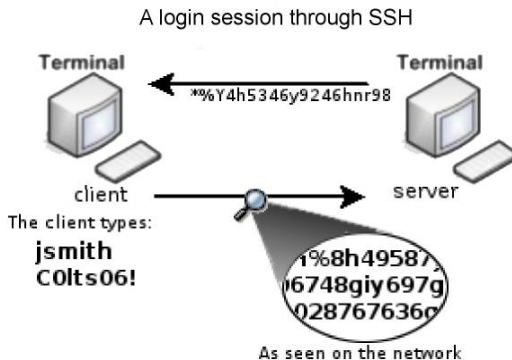

SSH CLI has a command line interface like shown below for example.

```
Generating public/private dsa key pair.  
Enter file in which to save the key (/home/localuser/.ssh/id_dsa):  
Enter passphrase (empty for no passphrase):  
Enter same passphrase again:  
Your identification has been saved in /home/localuser/.ssh/id_dsa.  
Your public key has been saved in /home/localuser/.ssh/id_dsa.pub.  
The key fingerprint is:  
93:58:20:56:72:d7:bd:14:86:9f:42:aa:82:3d:f8:e5 localuser@mybox.home.com
```

WEB MODE

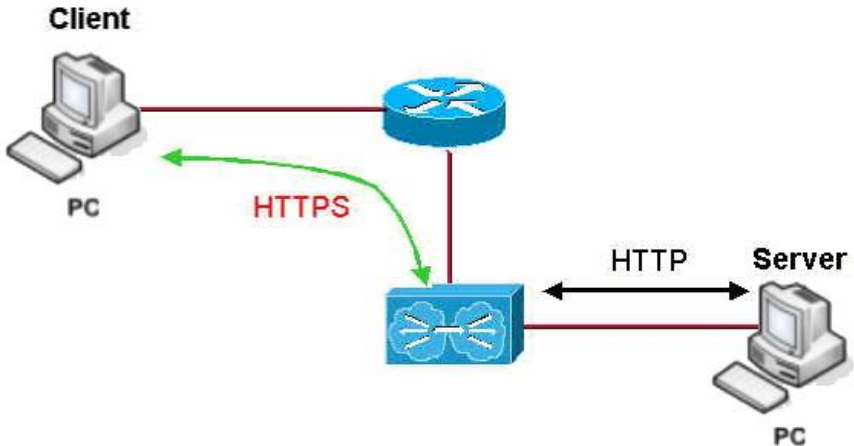

WP54AG supports HTTPS (SSL) in addition to the standard HTTP.

HTTPS (SSL) features additional authentication and encryption for secure communication.

Web Management Setup

1

Select **Web Management Setup** from the **CONFIGURATION** menu.

2

1. Select whether to set web server to HTTP or HTTPS (SSL) mode.
2. Click **Apply**.

Changes will be effected after reboot.

Web Management Setup

Mode

HTTP HTTPS (SSL)

Apply

SNMP SETUP

Simple Network Management Protocol (SNMP) is a set of communication protocols that separates the management architecture from the architecture of the hardware devices.

Step 1:

Click on **SNMP** from the **CONFIGURATION** menu.



The screenshot shows a window titled "SNMP Setup". Inside the window, there are three fields: "SNMP State" with a dropdown menu set to "Enable", "Read Password" with a masked password field (seven dots), and "Read/Write Password" with a masked password field (seven dots). Below these fields is an "Apply" button with a mouse cursor pointing to it.

Step 2:

Select **Enable** from the **SNMP State** drop-down list.

The default **Read Password** is set to *public* while the default **Read/Write Password** is *private*.

Step 3:

Click on the **Apply** button.

STP SETUP

(Only available in Access Point, Point to Point and Point to Multiple Point modes)

Spanning Tree Protocol (STP) is a link management protocol that helps to prevent undesirable loops occurs in the network. For an Ethernet network to function properly, only one active path can exist between two stations. If a loop exists in the network topology, duplication of messages will occur and this might confuse the forwarding algorithm and allow duplicate frames to be forwarded.

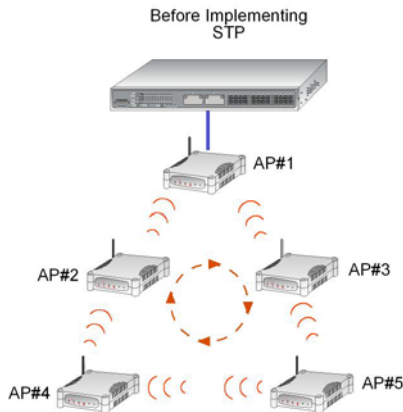

In short, the main purpose of activating STP is to prevent looping when you have redundant paths in the network. Without activating STP, redundant topology will cause broadcast storming.

To establish path redundancy, STP creates a tree that spans all of the devices in an extended network, forcing redundant paths into a standby, or blocked, state, but establishing the redundant links as a backup in case the active link should fail. If STP costs change, or if one network segment in the STP becomes unreachable, the spanning tree algorithm reconfigures the spanning tree topology and re-establishes the connection by activating the standby path. Without spanning tree in place, it is possible that more than one connection may be simultaneously live, which could result in an endless loop of traffic on the LAN.

Spanning-Tree Protocol operation is transparent to end stations, which are unaware whether they are connected to a single LAN segment or a switched LAN of multiple segments.

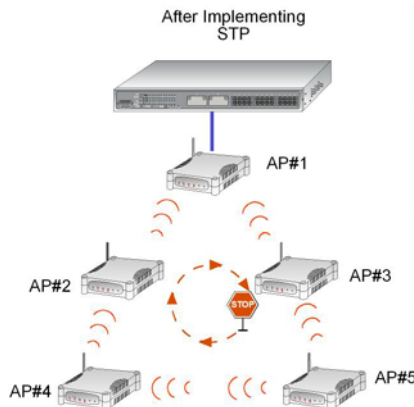

The path with the smallest cost will be used and extra redundant paths will be disabled.

To explain the effect of STP & Pseudo VLAN on the wireless clients, we will compare 3 separate scenarios.

Scenario #1 – (No STP, No Pseudo VLAN)

Referring to the illustration below, if the Spanning Tree Protocol (STP) and Pseudo VLAN are not implemented in a network, all clients (Notebook#1, #2, #3 & #4,) can access to one another, resulting in low level of data security. Due to the redundant paths found in this network, broadcast packets will be duplicated and forwarded endlessly resulting in a broadcast storm.

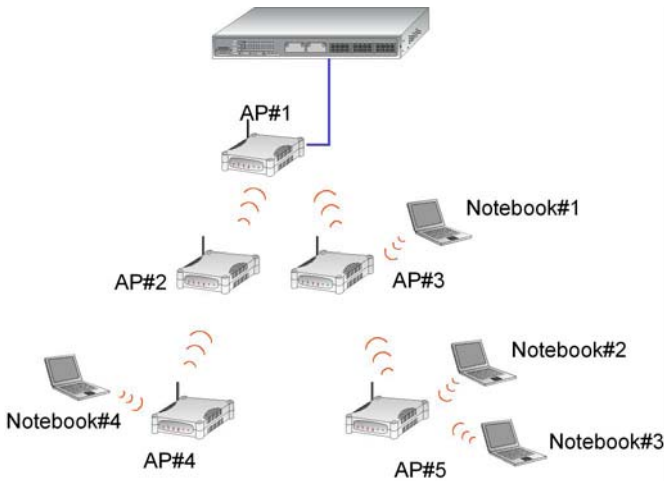

Scenario #2 – (With STP, No Pseudo VLAN)

When STP is enabled, extra redundant network paths between APs will be disabled, hence preventing multiple active network paths in-between any two APs.

If one of the APs is down, the STP algorithm will reactivate one of the redundant paths so that the network connection will not be lost.

All wireless users will be able to communicate with each other if they are associated to the APs that are in the same WDS zone.



Scenario #3 – (With STP and Pseudo VLAN)

In this example, both STP and Pseudo VLAN Per Node are implemented in this network. When Pseudo VLAN Per Node is activated, the wireless users will be unable to access one another.

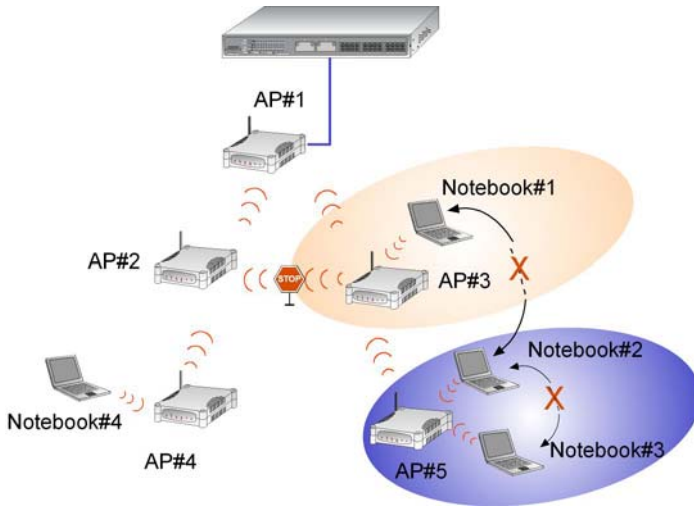

Step 1:

Click on **STP Setup** from the **CONFIGURATION** menu.

Step 2:

Select **Enable** from the **STP Status** radio button, fill in the fields, and click on the **Apply** button to update the changes.

Priority: (Default: 32768, Range: 0 – 65535)

This is the relative priority.

The lowest priority will be elected as the root.

Hello Time: (Default: 2, Range: 1 – 10)

This is the hello time.

Every (this number) seconds, a hello packet is sent out by.

Hello packets are used to communicate information about the topology throughout the entire STP network.

Forward Delay: (Default: 15, Range: 4 – 30)

The forward delay is the time that is spent in the listening and learning state.

Max Age: (Default: 20, Range: 6 – 40)

The max age timer controls the maximum length of time that passes before a port saves its configuration information.

Spanning Tree Protocol Setup

STP Status	<input checked="" type="radio"/> Enable <input type="radio"/> Disable
STP Designated Root	32768 00:80:48:3d:0f:80
Priority	<input type="text" value="32768"/> (32768:0-65535)
Hello Time	<input type="text" value="2"/> (2:1-10)
Forward Delay	<input type="text" value="15"/> (15:4-30)
Max Age	<input type="text" value="20"/> (20:6-40)

MAC FILTERING

MAC Filtering acts as a security measure by controlling the users accessing to the network through their MAC address. Each WLAN or radio card supports up to 16 virtual access points and has its own MAC address listing. The client MAC addresses entries can be set apply to all, or to only selected virtual access points.

Please note that MAC Filtering only filters wireless client MAC addresses. It does not filter the MAC addresses of computers connected to the Ethernet port, or the Ethernet network connection.

ADD A MAC ADDRESS TO THE MAC ADDRESS LIST.

Step 1:

Select **MAC Filtering** from **WLAN Setup(a/b/g)**.
MAC Address Filtering page displays.

In this page you may also set the MAC Filtering Status to **Enable** or **Disable** for access points and set the Policy to either **Accept** or **Deny** MAC addresses.

Status	Policy
Enable ▾	Accept ▾

MAC Filtering set to **Enable** with Policy to **Accept** only the MAC addresses in the MAC Filter Address List and deny all other MAC addresses.

Status	Policy
Enable ▾	Deny ▾

MAC Filtering set to **Enable** with Policy to **Deny** all the MAC addresses in the MAC Filter Address List and accept all other MAC addresses.

Status	Policy
Disable ▾	Accept ▾

MAC Filtering set to **Disable**. Whether Policy is set to **Enable** or **Deny** does not matter.

Status	Policy
Disable ▾	Deny ▾

MAC Filtering set to **Disable**. Whether Policy is set to **Enable** or **Deny** does not matter.

Click **Edit**.

(This displays the MAC Address List of individual virtual access points.)

MAC Address Filtering

Radio 1 MAC Filtering Options :

AP Type	ESSID	Security	MACs	Status	Policy
Main AP	sampleRouter	NONE	Edit	Enable ▾	Accept ▾
Virtual AP	VAP1	NONE	Edit	Disable ▾	Deny ▾
Virtual AP	VAP2	NONE	Edit	Enable ▾	Deny ▾

[View Complete MAC List](#)

(All changes will take effect after reboot)

Step 2:

MAC Filter Address List page displays.

Click the **Add** button.

MAC Filter Address List

MAC Address List
ESSID: "sampleRouter"

Del.	MAC Address	Comments	Apply to
------	-------------	----------	----------

(All changes will take effect after reboot)

Step 3:

Add MAC Address page displays.

Add MAC Address

MAC Address: (XX-XX-XX-XX-XX-XX)

Comment:

Apply to All:

Selected	AP ESSID	Security
<input checked="" type="checkbox"/>	sampleRouter	NONE
<input type="checkbox"/>	VAP1	NONE
<input type="checkbox"/>	VAP2	NONE

Step 4:

Enter the MAC Address of the client in the format **xx-xx-xx-xx-xx-xx**, where x can take any value in the range 0-9 or a-f.

Enter the Comment. This describes the MAC Address you have entered.

To apply to all virtual access points: Check **Apply to All**.

To apply to specific virtual access point: Select the checkbox of the corresponding AP.

Click the **Apply** button.

Add MAC Address

MAC Address (xx-xx-xx-xx-xx-xx)
Comment
Apply to All

Selected	AP ESSID	Security
<input checked="" type="checkbox"/>	sampleRouter	NONE
<input type="checkbox"/>	VAP1	NONE
<input type="checkbox"/>	VAP2	NONE

Step 5:

MAC Filter Address List page displays with updated MAC Address List.

MAC Filter Address List

MAC Address List
ESSID: "sampleRouter"

Del.	MAC Address	Comments	Apply to
<input type="checkbox"/>	08-70-f8-70-80-70	mac4	all

(All changes will take effect after reboot)



NOTE

Please reboot to effect all changes and new MAC address entries.

DELETE A MAC ADDRESS FROM ALL ACCESS POINTS.

Step 1:

Select **MAC Filtering** from **WLAN Setup(a/b/g)**.
MAC Address Filtering page displays.

Click **View Complete MAC List**.
(This displays the MAC Address List of the radio card.)

MAC Address Filtering

Radio 1 MAC Filtering Options :

AP Type	ESSID	Security	MACs	Status	Policy
Main AP	sampleRouter	NONE	Edit	Enable ▾	Accept ▾
Virtual AP	VAP1	NONE	Edit	Disable ▾	Deny ▾
Virtual AP	VAP2	NONE	Edit	Enable ▾	Deny ▾

[View Complete MAC List](#)

(All changes will take effect after reboot)

Step 2:

MAC Filter Address List page displays.

Select the checkbox of the MAC address you wish to delete.

Click the **Delete** button.



MAC Filter Address List

MAC Address List
Radio 1

Del.	MAC Address	Comments	Apply to
<input type="checkbox"/>	08-70-f8-70-80-70	mac1	all
<input checked="" type="checkbox"/>	00-b0-d0-86-bb-f7	mac3	1 AP(s)

(All changes will take effect after reboot)

Step 3:

MAC Filter Address List page displays with updated MAC Address List.



MAC Filter Address List

MAC Address List
Radio 1

Del.	MAC Address	Comments	Apply to
<input type="checkbox"/>	08-70-f8-70-80-70	mac1	all

(All changes will take effect after reboot)

DELETE A MAC ADDRESS FROM INDIVIDUAL ACCESS POINT.

Step 1:

Select **MAC Filtering** from **WLAN Setup(a/b/g)**.
MAC Address Filtering page displays.

Click **Edit** for the corresponding access point.

MAC Address Filtering

Radio 1 MAC Filtering Options :

AP Type	ESSID	Security	MACs	Status	Policy
Main AP	sampleRouter	NONE	Edit	Enable <input type="button" value="v"/>	Accept <input type="button" value="v"/>
Virtual AP	VAP1	NONE	Edit	Disable <input type="button" value="v"/>	Deny <input type="button" value="v"/>
Virtual AP	VAP2	NONE	Edit	Enable <input type="button" value="v"/>	Deny <input type="button" value="v"/>

[View Complete MAC List](#)

(All changes will take effect after reboot)

Step 2:

MAC Filter Address List page displays.

Select the checkbox of the MAC address you wish to delete.

Click the **Delete** button.

MAC Filter Address List

MAC Address List
ESSID: "sampleRouter"

Del.	MAC Address	Comments	Apply to
<input type="checkbox"/>	08-70-f8-70-80-70	mac1	all
<input checked="" type="checkbox"/>	09-70-f8-70-80-70	mac2	all
<input type="checkbox"/>	00-b0-d0-86-bb-f7	mac3	1 AP(s)

(All changes will take effect after reboot)

Step 3:

MAC Filter Address List page displays with updated MAC Address List.

MAC Filter Address List

MAC Address List
ESSID: "sampleRouter"

Del.	MAC Address	Comments	Apply to
<input type="checkbox"/>	08-70-f8-70-80-70	mac1	all
<input type="checkbox"/>	00-b0-d0-86-bb-f7	mac3	1 AP(s)

(All changes will take effect after reboot)

EDIT MAC ADDRESS FROM THE MAC ADDRESS LIST.

Step 1:

Select **MAC Filtering** from **WLAN Setup(a/b/g)**.
MAC Address Filtering page displays.

Click **Edit**.

AP Type	ESSID	Security	MACs	Status	Policy
Main AP	sampleRouter	NONE	Edit	Enable	Accept
Virtual AP	VAP1	NONE	Edit	Disable	Deny
Virtual AP	VAP2	NONE	Edit	Enable	Deny

[View Complete MAC List](#)

(All changes will take effect after reboot)

Step 2:

MAC Filter Address List page displays.
Select the MAC address to edit.

Del.	MAC Address	Comments	Apply to
<input type="checkbox"/>	08-70-f8-70-80-70	mac4	1 AP(s)

(All changes will take effect after reboot)

Step 3:

The Edit MAC Address page displays.
Edit the MAC address settings accordingly.

Click **Save**.

Edit MAC Address

MAC Address: (XX-XX-XX-XX-XX-XX)

Comment

Apply to All

Selected	AP ESSID	Security
<input type="checkbox"/>	sampleRouter	NONE
<input checked="" type="checkbox"/>	VAP1	NONE
<input type="checkbox"/>	VAP2	NONE

Step 4:

MAC Filter Address List page displays with updated MAC Address List.

MAC Filter Address List

MAC Address List
ESSID: "VAP1"

Del.	MAC Address	Comments	Apply to
<input type="checkbox"/>	<u>08-70-f8-70-80-70</u>	mac4	all

(All changes will take effect after reboot)

Chapter 5: WLAN Security

This section illustrates how to make your WLAN more secure. All the nodes in your network MUST share the same wireless settings to be able to communicate.

We will illustrate how to configure each type of security mode individually.

To start with, follow the common preliminary steps described below to select the most appropriate security approach for protecting your wireless communications.

Step 1:

Click on **WLAN Setup** from the **CONFIGURATION** menu to select **Security**.

Step 2:

Make a selection from the **Security Mode** drop down menu. The **Security Mode** is set to **NONE** by default.

Click on the **Apply** button.

WLAN Security Setup

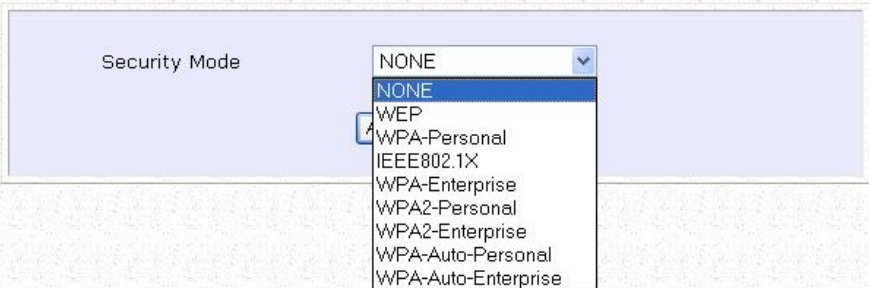

The screenshot shows the 'WLAN Security Setup' configuration page. A light blue box contains the 'Security Mode' label and a dropdown menu. The dropdown menu is open, showing a list of security modes: NONE (highlighted in blue), WEP, WPA-Personal, IEEE802.1X, WPA-Enterprise, WPA2-Personal, WPA2-Enterprise, WPA-Auto-Personal, and WPA-Auto-Enterprise. The 'NONE' option is currently selected.

HOW TO SET UP WEP

The guidelines below will help you to set up your access point for using WEP.

At the **WEP Setup** page,

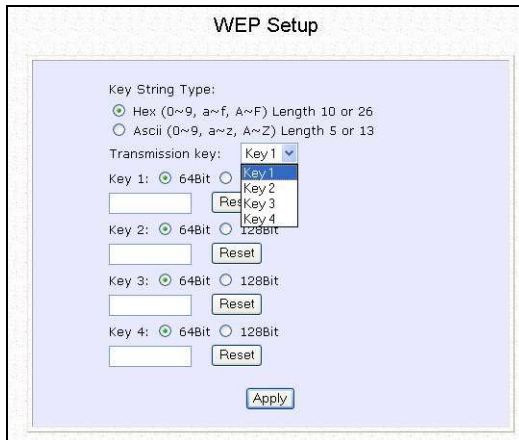

The screenshot shows the 'WEP Setup' configuration page. It includes the following elements:

- Key String Type:** Two radio buttons are present: 'Hex (0~9, a~f, A~F) Length 10 or 26' (which is selected) and 'Ascii (0~9, a~z, A~Z) Length 5 or 13'.
- Transmission key:** A dropdown menu is set to 'Key 1'. A list of options is visible: 'Key 1', 'Key 2', 'Key 3', and 'Key 4'. A 'Reset' button is located to the right of the dropdown.
- Key 1:** A radio button for '64Bit' is selected, with an empty text input field below it and a 'Reset' button to its right.
- Key 2:** A radio button for '64Bit' is selected, with an empty text input field below it and a 'Reset' button to its right.
- Key 3:** A radio button for '64Bit' is selected, with an empty text input field below it and a 'Reset' button to its right.
- Key 4:** A radio button for '64Bit' is selected, with an empty text input field below it and a 'Reset' button to its right.
- Apply:** A single 'Apply' button is located at the bottom center of the form.

Step 1:

Specify the **key entry type**, by selecting either:

- **Use Hexadecimal:**
- **Use ASCII**

Step 2:

Select the **Transmission Key** from the pull down menu:

- **Key 1**
- **Key 2**
- **Key 3**
- **Key 4**

The access point lets you define up to four different transmission keys. It defines a set of shared keys for network security. You must enter at least one WEP key to enable security using a shared key.

Step 3:

Select the **length** of each encryption key:

- **64-bit WEP**
10 hexadecimal or 5 ASCII Text
- **128-bit WEP**
26 hexadecimal or 13 ASCII Text

To clear the values that you had entered in the field, click on the **Reset** button.

Click on the **Apply** button and reboot your access point.

HOW TO SET UP WPA-PERSONAL

(Only available in Access Point mode)

The guidelines below will help you to set up the access point for using WPA-Personal. Please follow the steps below if you have activated **WPA-Personal**, **WPA2-Personal** or **WPA-Personal-AUTO** security modes.

At the **WPA1/2-PSK Setup** page,

WPA1/2-PSK Setup

Key String Type:

Hexadecimal(64 hex digits)

Passphrase(8~63 ascii characters)

WPA-PSK:

Cipher Type: (60~9999)

GTK Update(seconds): (60~9999)

Apply

Step 1:

Specify the **key entry type**, by selecting either:

- **Passphrase (Alphanumeric characters)**
- **Hexadecimal**

Step 2:

Fill in the pre-shared network key:

If you are using the **Passphrase** format, your entry can consist of a minimum of 8 alphanumeric characters or a maximum of 63 alphanumeric characters.

Otherwise, when using the **Hexadecimal** format, your entry MUST consist of 64 hexadecimal characters.

Step 3:

For WPA-Personal

Set the **Cipher Type** to **TKIP**.

WPA replaces WEP with a strong encryption technology called Temporal Key Integrity Protocol (TKIP) with Message Integrity Check (MIC).

For WPA2-Personal

Set the **Cipher Type** to **AES**.

Advanced Encryption Standard (AES) is a stronger symmetric 128-bit block data encryption technique. AES is a requirement of WPA2 under the IEEE 802.11i standard.

For WPA-Personal-AUTO

Set the **Cipher Type** to **Auto** to allow the access point to automatically detect the cipher type to use.

Step 4:

Enter the **GTK (Group Transient Key) Updates**.

This is the length of time after which the access point will automatically generate a new shared key to secure multicast/broadcast traffic among all stations that are communicating with it. By default, the value is 600 seconds.

Step 5:

Press the **Apply** button and reboot your system, after which your settings will become effective.

HOW TO SET UP 802.1X/RADIUS

(Only available in Access Point mode)

The guidelines below will help you to set up the access point for using 802.1x/RADIUS.

At the IEEE 802.1x Setup page,

IEEE 802.1X Setup	
Primary RADIUS Server IP	0.0.0.0
Secondary RADIUS Server IP	0.0.0.0
Authentication Port	1812
Accounting Port	1813
Shared Secret Key	••••••••••
Broadcast Key Rotation(seconds)	600 (60~9999)
Key Length	64 bits 64 bits 128 bits
Apply	

Step 1:

Key in the IP address of the **Primary RADIUS Server** in your WLAN. You can optionally add in the IP address of a **Secondary RADIUS Server**, if any.

The RADIUS authentication server MUST be in the same subnet as the access point.

Step 2:

By default, the value for **Authentication Port** number is **1812**. You can leave this value as it is. This value must be set to be the same as the one in the RADIUS server.

Step 3:

By default, the value for **Accounting Port** number is **1813**. You can leave this value as it is. This value must be set to be the same as the one in the RADIUS server.

Step 4:

Enter the **Shared Secret Key** in the field provided.

Step 5:

By default, the **Broadcast Key Rotation** is set as **600** seconds. You may leave this value as its default setting.

Step 6:

Select the **length** of each encryption key:

- **64-bit**
10 hexadecimal or 5 ASCII Text
- **128-bit**
26 hexadecimal or 13 ASCII Text

Step 7:

Press the **Apply** button and reboot your system, after which your settings will become effective.

HOW TO SET UP WPA ENTERPRISE

(Only Access Point mode supports WPA2-Enterprise and WPA-Enterprise-AUTO)
The guidelines below will help you to set up the access point for using WPA- Enterprise. Please follow the steps below if you have selected the WPA or WPA1- Enterprise, WPA2- Enterprise or WPA- Enterprise -AUTO.

At the **WPA1/2-EAP Setup** page,

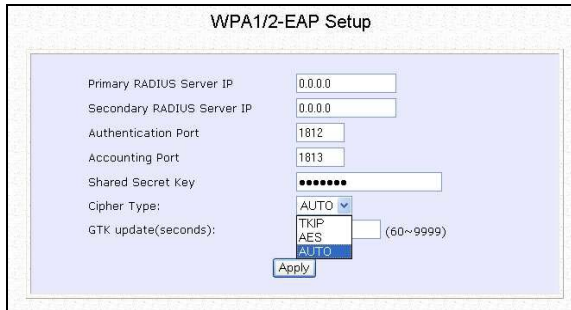

The screenshot shows the 'WPA1/2-EAP Setup' configuration page. It contains the following fields and options:

- Primary RADIUS Server IP: 0.0.0.0
- Secondary RADIUS Server IP: 0.0.0.0
- Authentication Port: 1812
- Accounting Port: 1813
- Shared Secret Key: [Masked with 8 dots]
- Cipher Type: AUTO (dropdown menu)
- GTK update(seconds): TKIP, AES (radio buttons), (60~9999)
- Apply button

Step 1:

Key in the IP address of the **Primary RADIUS Server** in your WLAN.

You can optionally add in the IP address of a **Secondary RADIUS Server**, if any. The RADIUS authentication server MUST be in the same subnet as the access point.

Step 2:

By default, the value for **Authentication Port** number is **1812**. You can either leave this value as it is or key in a different Authentication Port but it MUST match the corresponding port of the RADIUS server.

Step 3:

By default, the value for **Accounting Port** is **1813**. You can leave this value as it is. This value must be set to be the same as the one in the RADIUS server.

Step 4:

Enter the **Shared Secret Key** used to validate client-server RADIUS communications.

Step 5:

Select the **length** of each encryption key:

- **64-bit**
10 hexadecimal or 5 ASCII Text
- **128-bit**
26 hexadecimal or 13 ASCII Text

Step 6:

For WPA-Enterprise

Set the **Cipher Type** to **TKIP**.

WPA replaces WEP with a strong encryption technology called Temporal Key Integrity Protocol (TKIP) with Message Integrity Check (MIC).

For WPA2- Enterprise

Set the **Cipher Type** to **AES**.

Advanced Encryption Standard (AES) is a symmetric 128-bit block data encryption technique. It is a requirement of WPA2 under the IEEE 802.11i standard.

For WPA- Enterprise -AUTO

Set the **Cipher Type** to **Auto** to allow the access point to automatically detect the cipher type to use.

Step 7:

Enter the **GTK (Group Transient Key) Updates**.

This is the length of time after which the access point will automatically generate a new shared key to secure multicast/broadcast traffic among all stations that are communicating with it. By default, the value is 600 seconds.

Step 8:

Press the **Apply** button and reboot your system, after which your settings will become effective.

Chapter 6: Wireless Extended Features

This section illustrates how to configure the wireless extended features. To start with, follow the common preliminary steps described below.

ACCESS CONTROL – THE WIRELESS PSEUDO VLAN

(Only in Access Point mode)

A **VLAN** is a group of PCs or other network resources that behave as if they were connected to a single network segment although they may be physically located on different segments of a LAN.

Those stations which are assigned to the same VLAN share network resources and bandwidth as if they were connected to the same segment. Conversely, only the stations within the same VLAN can access each other.

A **Wireless Pseudo VLAN** acts by segregating a single wireless LAN into multiple VLANs so that communication is possible only among wireless clients within the same VLAN.

When operating in the **Access Point** mode, Access point allows you to define *Wireless Pseudo VLAN Per Node* and *Wireless Pseudo VLAN Per Group*.

To learn more about Compex's exclusive **Wireless Pseudo VLAN**, please refer to the white paper available online at www.cpx.com or www.compex.com.sg.

WIRELESS PSEUDO VLAN PER NODE

When implemented, this mode isolates each wireless client into its own pseudo VLAN. Wireless clients can therefore access resources on the wired network but are unable to see each other or access each other's data.

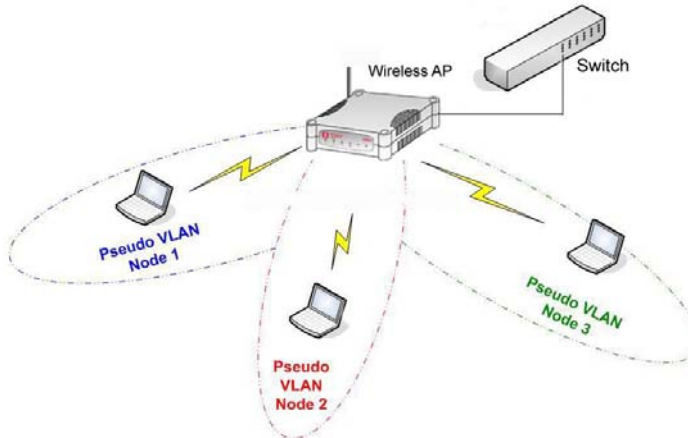

The following steps demonstrate how to set up a Wireless Pseudo VLAN per Node.

Step 1:

From **WLAN Setup** under Configuration, click on **Advanced**, which shows the **WLAN Advanced Setup** page.

Step 2:

Go to the **Extended Features** section, and click on the **Wireless Pseudo VLAN** button.

The image shows two screenshots from a network configuration interface. The top screenshot is titled "WLAN Advanced Setup" and contains the following settings:

Beacon Interval	100	(100:20-1000)
Data Beacon Rate (DTIM)	1	(1:1-16384)
RTS/CTS Threshold	2312	(2312:1-2312)
Frag Threshold	2346	(2346:256-2346)
Transmit Power	Maximum	▼
Radio Off When Ethernet Link Down	<input type="checkbox"/>	
Antenna Control	Auto	▼

Below these settings is an "Apply" button.

The bottom screenshot is titled "Extended Features" and contains three buttons: "Wireless Pseudo VLAN", "WDS Configuration", and "Long Distance Parameters". The "Wireless Pseudo VLAN" button is highlighted with a blue border.

Step 3:

The **Wireless Pseudo VLAN** function is disabled by default. Click on the **Change** button to make your selection of the type of Pseudo VLAN to implement.

Step 4:

Select the **Per node** radio button and click on the **Apply** button.

Select Wireless Pseudo VLAN Type

Disable

Per node

Per group

The Wireless Pseudo VLAN has configured as Per node.

Wireless Pseudo VLAN

Type : Per node

WIRELESS PSEUDO VLAN PER GROUP

The access point can configure up to 32 'groups' of wireless clients identified by their MAC address. Whenever a wireless client requests network access, the access point will first verify whether its MAC address is present in any of the Pseudo VLAN groups. If it is, the access point will grant it access to the wired system resources and to all other wireless clients belonging to the same Pseudo VLAN group only.

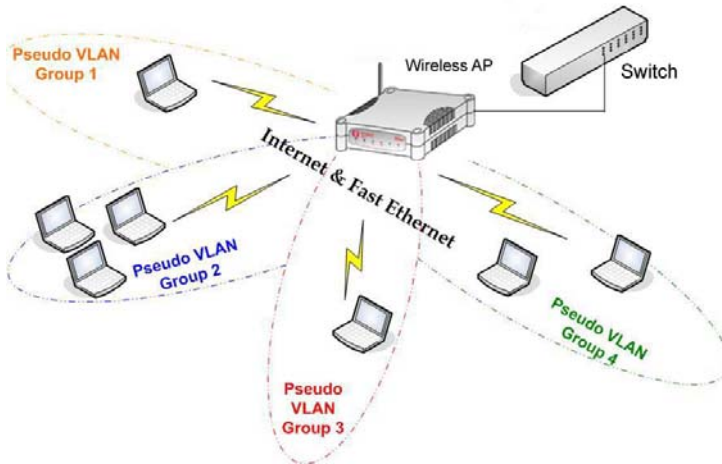

The following steps demonstrate how to set up Wireless Pseudo VLAN Groups.

CREATE A CLIENT IN A PSEUDO VLAN GROUP

Step 1:

From the **Select Wireless Pseudo VLAN Type** page, select **Per group** and click on the **Apply** button.

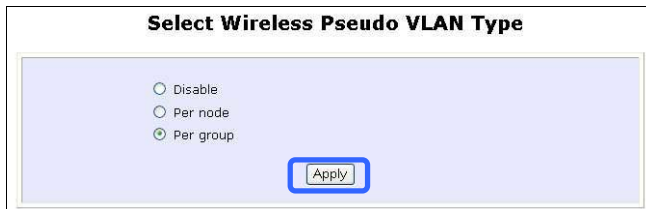

The screenshot shows a configuration page titled "Select Wireless Pseudo VLAN Type". It contains three radio button options: "Disable", "Per node", and "Per group". The "Per group" option is selected. Below the options is an "Apply" button.

Step 2:

Click on the **Add** button to create a client in the Wireless Pseudo VLAN group.



The screenshot shows a configuration page titled "Wireless Pseudo VLAN". It displays "Type : Per group" with a "Change" button next to it. Below this is a table with two columns: "Group" and "Hardware Address". An "Add" button is located below the table.

Step 3:

Select a group number from the **Group** drop-down list.

Add Wireless Pseudo VLAN Entry

Group:

Hardware Address: (xx-xx-xx-xx-xx-xx)

Step 4:

Fill in the **Hardware Address** field with the MAC address of the client in the format **xx-xx-xx-xx-xx-xx**, where x is any value within the range 0-9 or a-f.

Step 5:

Click on the **Add** button to update the changes.

The Pseudo VLAN group has been added to the list as shown below.

Wireless Pseudo VLAN

Type : Per group

Group	Hardware Address
01	00-80-45-e5-0d-05



NOTE

A client can be a member of more than one Pseudo VLAN group. For instance, if a client is a member of wireless Pseudo VLAN groups 01 and 02, it will be able to communicate with the other clients in both groups.

ADD ANOTHER CLIENT IN A PSEUDO VLAN GROUP

Follow the procedures mentioned in Steps 3-5. You can create up to 32 members per Wireless Pseudo VLAN group.

EDIT/DELETE A CLIENT IN A PSEUDO VLAN GROUP

Step 1:

Click on the **MAC address** in the table as shown below.

Wireless Pseudo VLAN

Type : Per group

Group	Hardware Address
01	00-80-45-e5-0d-05

Step 2:

From the **Edit Wireless Pseudo VLAN Entry** page,

Click on the **Delete** button to remove the client from the group, or Click on the **Save** button after you had edited the entry.

Edit Wireless Pseudo VLAN Entry

Group:

Hardware Address: (XX-XX-XX-XX-XX-XX)

WIRELESS SETUP - THE WIRELESS DISTRIBUTED SYSTEM

(Only in Access Point mode)

A wireless distribution system creates a wider network in which mobile users can roam while still staying connected to the available network resources by linking up several access points.

In a WDS, the access point can drive a cell of wired and wireless clients while at the same time, connecting to other access points. This requires the operational frequency channel to be the same within the cell controlled by your access point as well as for its wireless links to the other access points.

Star Configuration WDS

In a star configuration WDS, links are established between one root Access point and several satellite wireless APs positioned to increase the area covered.

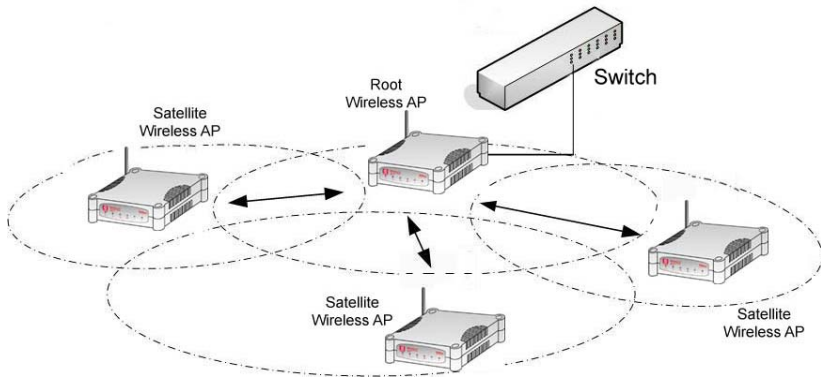

Here, the root Wireless AP connects to the wired network and maintains three WDS links while each satellite Wireless AP (Access Point) maintain a WDS link for communication with the root.

Chain Configuration WDS

A chain configuration WDS spans an area in length, for instance a long corridor. Satellite access points are chained together starting from a root access point.

The access point at either end of the chain will have only one WDS link enabled, while the access points in the middle will have two WDS links configured to associate with the neighboring Access point upward and downward in the chain.

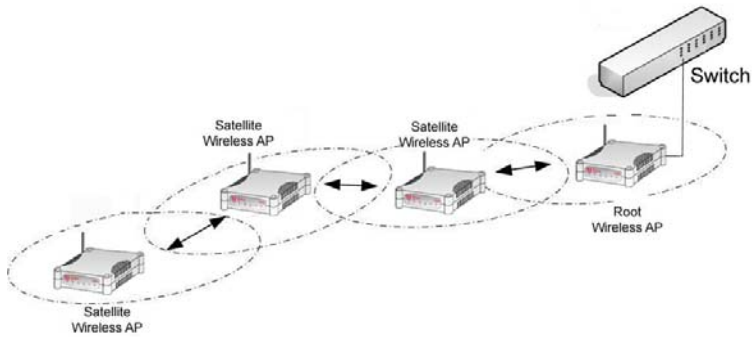

The following steps will guide you in setting up WDS in your access point.

CREATE A CLIENT IN A WDS

Step 1:

From **WLAN Setup** under Configuration, click on **Advanced**, which shows the **WLAN Advanced Setup** page.

Step 2:

Go to the **Extended Features** section, and click on the **WDS Configuration** button.

The image shows a screenshot of a web interface for configuring WLAN settings. The top section is titled "WLAN Advanced Setup" and contains several configuration options:

Beacon Interval	<input type="text" value="100"/>	(100:20-1000)
Data Beacon Rate (DTIM)	<input type="text" value="1"/>	(1:1-16384)
RTS/CTS Threshold	<input type="text" value="2312"/>	(2312:1-2312)
Frag Threshold	<input type="text" value="2346"/>	(2346:256-2346)
Transmit Power	<input type="button" value="Maximum"/>	
Radio Off When Ethernet Link Down	<input type="checkbox"/>	
Antenna Control	<input type="button" value="Auto"/>	

Below these settings is an "Apply" button. The bottom section is titled "Extended Features" and contains three buttons: "Wireless Pseudo VLAN", "WDS Configuration", and "Long Distance Parameters".

Step 3:

As illustrated on the **WDS Setup**, the **WDS** feature is disabled by default. Click on the **Change** button.



WDS Configuration

WDS Status : Disable

Step 4:

From the **Enable/Disable WDS** page, select **Enable** and click on the **Apply** button.



Enable/Disable WDS

Enable Enable the wireless wds function
 Disable Disable the wireless wds function

Step 5:

Click on the **Add** button to create a MAC address of a client.

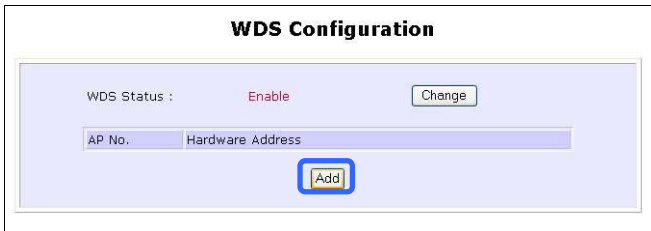

WDS Configuration

WDS Status : Enable

Step 6:

Fill up the **Hardware Address** field with the wireless MAC address of the device to include in your WDS, using the format xx-xx-xx-xx-xx-xx, where x can take any hexadecimal value 0-9 or a-f.

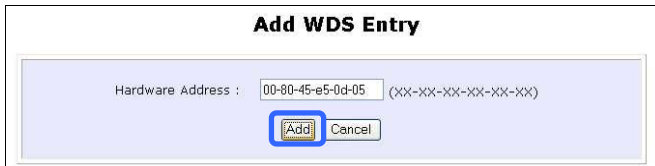

Add WDS Entry

Hardware Address : (xx-xx-xx-xx-xx-xx)

Click on the **Add** button to update the table.

Step 7:

From the **WDS Configuration** page, notice that the MAC Address has been added to the table as shown below.

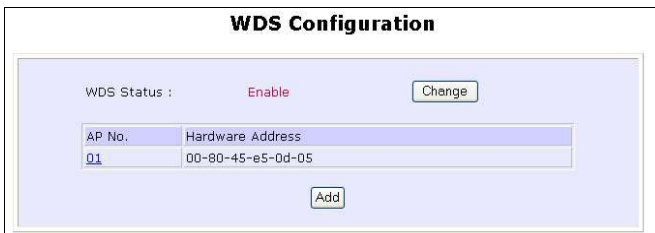

WDS Configuration

WDS Status : Enable

AP No.	Hardware Address
01	00-80-45-e5-0d-05



NOTE

To configure WDS, all your access points must use the same channel and security mode and both access points at opposite ends of a WDS link must have each other's wireless MAC address

ADD ANOTHER CLIENT IN A PSEUDO VLAN GROUP

Follow the procedures mentioned in Step 5 to Step 7.

EDIT/DELETE A CLIENT IN A WDS

Step 1:

Click on the **MAC address** in the table as shown below.

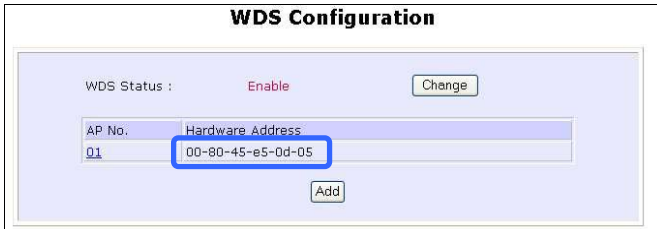

WDS Configuration

WDS Status : **Enable**

AP No.	Hardware Address
01	00-80-45-e5-0d-05

Step 2:

From the **Edit WDS Entry** page,

Click on the **Delete** button to remove the client from the WDS, or
Click on the **Save** button after you have edited the entry.

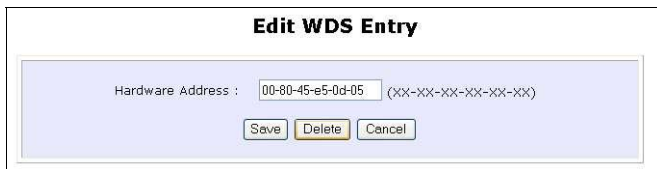

Edit WDS Entry

Hardware Address : (XX-XX-XX-XX-XX)

LONG DISTANCE PARAMETERS

This setup allows the access point to calculate and display suggested values for certain parameters to use to ensure that wireless communication takes place efficiently and effortlessly between physically distant APs. The following steps demonstrate how to configure the Long Distance Parameters.

Step 1:

From **WLAN Setup** under Configuration, click on **Advanced**, which shows the **WLAN Advanced Setup** page.

Step 2:

Go to the **Extended Features** section, and click on the **Long Distance Parameters** button.

The image shows a screenshot of a web interface for configuring an access point. It is divided into two main sections: "WLAN Advanced Setup" and "Extended Features".

WLAN Advanced Setup

Beacon Interval	<input type="text" value="100"/>	(100:20-1000)
Data Beacon Rate (DTIM)	<input type="text" value="1"/>	(1:1-16384)
RTS/CTS Threshold	<input type="text" value="2312"/>	(2312:1-2312)
Frag Threshold	<input type="text" value="2346"/>	(2346:256-2346)
Transmit Power	<input type="button" value="Maximum"/>	
Radio Off When Ethernet Link Down	<input type="checkbox"/>	
Antenna Control	<input type="button" value="Auto"/>	

Extended Features

Step 3:

As illustrated on the **Long Distance Parameters** Setup page, the **Outdoor** feature is disabled by default. Select **Enable** from the pull down menu.

Long Distance Parameters

Outdoor: Enable

Distance(meter): 120

SlotTime(us): 9

ACKTimeOut(us): 18

CTSTimeOut(us): 18

Show Reference Data

Note: Enter the distance of the client from the AP, a set for recommended parameters for SlotTime, ACKTimeOut and CTSTimeOut will be computed. You can use the recommended parameters or make your own fine tunings. Changes made will only take effect after rebooting.

Apply

Step 4:

The access point can automatically calculate the values of the parameters to input based on the distance between your access point and the other wireless device. Enter the distance in meters and click on **Show Reference Data**.

Long Distance Parameters

Outdoor: Enable

Distance(meter): 100

Show Reference Data

Microsoft Internet Explorer

Recommended slottime: 10 ;acknowdege timeout: 23; cts timeout:23

OK

Note: Enter the distance of the client from the AP, a set for recommended parameters for SlotTime, ACKTimeOut and CTSTimeOut will be computed. You can use the recommended parameters or make your own fine tunings. Changes made will only take effect after rebooting.

Step 5:

You can enter the parameters according to the recommended values in the pop-up window, click on the **Apply** button to update the changes.

This table describes the parameters that can be modified in the **Long Distance Parameters** page.

Parameters	Description
Outdoor	The Outdoor parameter is disabled by default. If set to Enable, the Outdoor parameters will be configured for outdoor communication over short or long distances as specified.
Distance	This parameter determines the distance between your access point and the remote access point. It should be entered in meters.
Slot Time	Time is slotted and each unit of time is called one slot time.
ACK Timeout	This parameter determines the timeout allowed for the sending client to receive the acknowledgment response from the receiving client. If no acknowledgment packet is received within this period, the sender will assume the receiver has not received the packet and will attempt to re-send.
CTS Timeout	This Clear-to-Send time is the time the wireless sender will wait for a CTS packet signaling that the channel is idle and it can start data transmission. If no CTS packet is received within this period, the sender will assume the channel is busy and will wait before trying to send again.

Chapter 7: Advanced Configuration

ROUTING

(only supported by Wireless Routing Client and Gateway)

The access point allows the network administrator to add a static routing entry into its routing table so that the access point can re-route IP packets to another network access point. This feature is very useful for a network with more than one access point.



Important:

You do NOT need to set any routing information if you are simply configuring the access point for broadband Internet sharing. Improper routing configuration will cause undesired effect.

The diagram below illustrates a case in which you have two routers in the network. One router is used for broadband Internet sharing while another router connects to a remote office. You may then define a static routing entry in the access point to re-route the packets to the remote office.

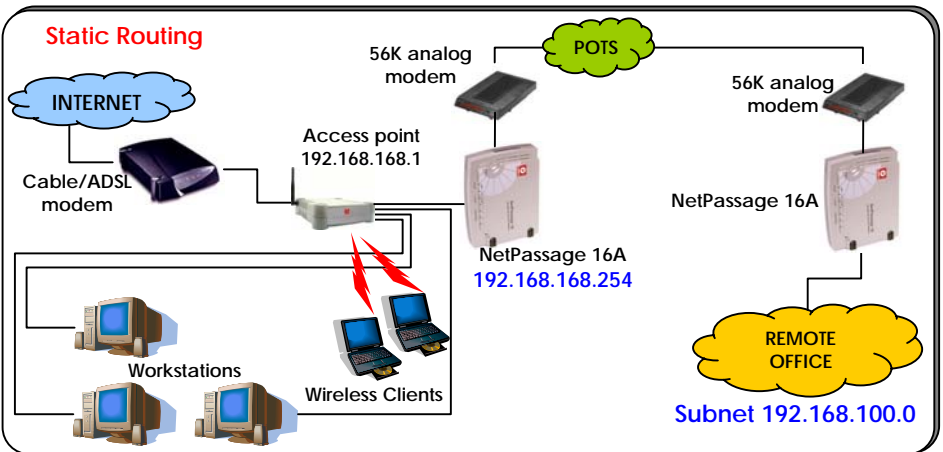

In this network, the main office of subnet 192.168.168.0 contains two routers: the office is connected to the Internet via the access point (192.168.168.1) and to the remote office via NetPassage 16A (192.168.168.254). The remote office resides on a subnet 192.168.100.0.

You may add a static routing entry into the access point's routing tables so that IP packets from the clients in the main office with a destination IP address of 192.168.100.X (where X is any number from 2 to 254) will be routed to the NetPassage 16A Router, which acts as the gateway to that subnet.

TO CONFIGURE STATIC ROUTING OF WP54AG

With an understanding of how adding a static routing entry can facilitate a network setup such as the one described above, here is how you may configure the access point:

Step 1:

Under the **CONFIGURATION** command menu, click on **Routing** to be brought to the **System Routing Table** shown (on the right). Initially, the table will contain the default routing entries built into Access point.

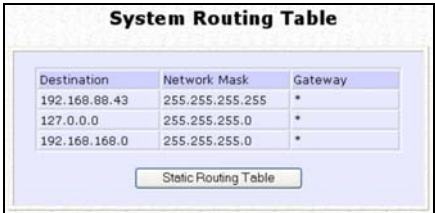

Destination	Network Mask	Gateway
192.168.88.43	255.255.255.255	*
127.0.0.0	255.255.255.0	*
192.168.168.0	255.255.255.0	*

Static Routing Table

Static Routing Table

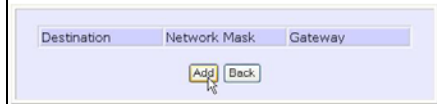

Destination	Network Mask	Gateway
-------------	--------------	---------

Add Back

Step 2:

Click on the **Static Routing Table** button above.

On this page, click the **Add** button.

Step 3:

You may specify the **Destination IP Address**, **Destination Net Mask** and **Gateway IP Address** here. For this example, they are 192.168.100.0, 255.255.255.0 and 192.168.168.254 respectively. Hit the **Add** button to finish.



Destination IP Address :	192.168.100.0
Destination Net Mask :	255.255.255.0
Gateway IP Address :	192.168.168.254

Add Cancel

When the entry is added, it is reflected in the **Static Routing Table**.

Destination	Network Mask	Gateway
192.168.100.0	255.255.255.0	192.168.168.254

NAT

(only supported by Wireless Routing Client and Gateway)

The basic purpose of NAT is to share a single public IP address when there are multiple PCs in the private network by using different TCP ports to identify requests coming from different PCs. NAT is enabled by default.

Due to NAT, computers in the private LAN behind the access point will not be directly accessible from the Internet. However, employing virtual Servers lets you host Internet servers behind the NAT by way of IP/Port Forwarding as well as De-Militarized Zone hosting.

To learn more about NAT and its complementary technologies, please turn to the NAT Technology Primer found on the Product CD.

Learn more from our **NAT Technology Primer**

Step 1:

Under the **CONFIGURATION** command menu, click on **NAT**. NAT is enabled by default. To disable it, click **Disable**.



Step 2:

Click **Apply** to effect the setting.



Important:

Do NOT disable NAT unless absolutely necessary. Disabling NAT will disable broadband Internet sharing effectively.

TO CONFIGURE VIRTUAL SERVERS BASED ON DE-MILITARIZED ZONE HOST

Having gone through the NAT Technology Primer on the Product CD, you would now have a good understanding of how DMZ works to make a specific PC in an NAT-enabled network directly accessible from the Internet.

When NAT is enabled, an Internet request from a client within the private network first goes to the access point receiving a request, the access point keeps track of which client is using which port number. Since any reply from Internet goes to the access point first, the access point (from the port number in the reply packet) knows to which client to forward the reply. If the access point does not recognize the port number, it will discard the reply.

When using DMZ on a PC, any reply not recognized by the access point will be forwarded to the DMZ-enabled PC instead.



Step 1:

Under the **CONFIGURATION** command menu, click on **NAT**. You will find the **Advanced NAT Options** available near the bottom of the page.

Step 2:

Click the **DMZ** button to configure Virtual Servers based on De-Militarized Zone host.

Step 3:

On the **NAT DMZ IP Address** page, you have to define the **Private IP Address** of the DMZ host. In this example, we keyed in the private IP address for the PC we wish to place



within the DMZ : 192.168.168.55

(Enter **0.0.0.0** as the **Private IP Address** and it will disable DMZ).

Remember to click the **Apply** button.



NOTE

1. When you enable DMZ, the Static IP Address configuration is recommended for the DMZ host. Otherwise, if the address is allocated by DHCP, it may change and DMZ will not function properly.
 2. DMZ allows the host to expose ALL of its parts to the Internet. The DMZ host is thus susceptible to malicious attacks from the Internet.
-

TO CONFIGURE VIRTUAL SERVERS BASED ON PORT FORWARDING

Virtual Server based on Port Forwarding is implemented to forward Internet requests arriving at the access point's WAN interface, based on their TCP ports, to specific PCs in the private network. If you require more information on this function, please refer to the NAT Technology Primer on the Product CD.



Step 3:
Hit the **Add** button on the **Port Forward Entries** page.

Step 1:

Under the **CONFIGURATION** command menu, click on **NAT**. You will find the **Advanced NAT Options** available near the bottom of the page.

Step 2:

Click the **Port Forwarding** button to configure Virtual Servers based on Port Forwarding.



Add Port Forward Entry

Known Server

Server Type : HTTP

Private IP Address :

Public IP : All

From :

To :

Add Help Cancel

Custom Server

Server Type : LAN Game

Protocol : UDP

Public Port : Range

From : 15

To : 89

Private IP Address : 192.168.168.55

Private Port From : 30

Public IP : All

From :

To :

Add Cancel

Step 4:

On the following **Add Port Forward Entry** screen, you can set up a Virtual Server for a **Known Server** type by selecting from a drop-down menu OR you can define a **Custom Server**.

For a more detailed explanation, please refer to the NAT Technology Primer found on the Product CD.

Learn more from our **NAT Technology Primer**

Known Server

- Server Type** : Select from the drop-down list of known server types: (HTTP, FTP, POP3 or Netmeeting).
- Private IP Address** : Specify the LAN IP address of your server PC running within the private network.
- Public IP From** : Select **All**, **Single**, or **Range** from the dropdown list.
- To** : Enter the beginning of the range.
- To** : Enter the end of the range.

Custom Server

- Server Type** : Define a name for the server type you wish to configure.
- Protocol** : Select either **TCP** or **UDP** protocol type from the dropdown list.
- Public Port** : Select whether to define a single port or a range of public port numbers to accept.
- From** : Starting public port number
- To** : Ending public port number. If the Public Port type is Single, this field will be ignored.
- Private IP Address** : Specify the IP address of your server PC running within the private network.
- Private Port From** : Starting private port number. The ending private port number will be calculated automatically according to the public port range.
- Public IP From** : Select **All**, **Single**, or **Range** from the dropdown list.
- To** : Enter the beginning of the range.
- To** : Enter the end of the range.

As an example, if you want to set up a web server on a PC with IP address of 192.168.168.55, select HTTP as **Server Type** and enter **192.168.168.55** as the **Private IP Address**. Click on the **Add** button. You will see the entry reflected as on the right.

Port Forward Entries

Server Type	Protocol	Public Port	Private IP	Private Port
HTTP	TCP	80	192.168.168.55	80

TO CONFIGURE VIRTUAL SERVERS BASED ON IP FORWARDING

When you have subscribed for more than one IP address from your ISP, you may define Virtual Servers based on IP Forwarding for which all Internet requests, regardless of ports, are forwarded to defined computers in the private network. If you require more information of its function, please refer to the NAT Technology Primer on the Product CD. Here are the steps to set it up:



Step 1:

Under the **CONFIGURATION** command menu, click on **NAT**. You will find the **Advanced NAT Options** available near the bottom of the page.

Step 2:

Click the **IP Forwarding** button to configure Virtual Servers based on IP Forwarding.

Step 3:

At the next screen **Add IP Forward Entry**, you have to specify a **Private IP Address** and a **Public IP Address**. In this example, we would like all requests for 213.18.213.101 to be forwarded to a PC with **Private IP Address** 192.168.168.55.

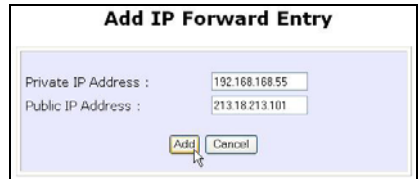

Step 4:

Click the **Add** button to continue.

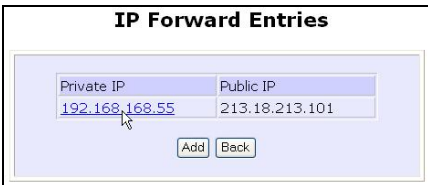

Step 5:

The **IP Forward Entries** page will reflect your new addition.



NOTE

For step 3 above, please ensure that you have subscribed to the Public IP Address you intend to forward from.

BANDWIDTH CONTROL

(only supported by Wireless Routing Client and Gateway)

The access point is designed to support simple bandwidth management that makes use of the **Bandwidth Control**. This feature gives the administrator the choice to manage the bandwidth control of subscribers in case of massive data transfer that causes slowdown problems when surfing the Internet.

TO ENABLE OR DISABLE BANDWIDTH CONTROL

Only two simple steps are required to enable or disable bandwidth control for the access point.

Step 1:

Under the **CONFIGURATION** command menu, click on **Bandwidth Control**, and you will be brought to the following screen.

Enable/Disable Bandwidth Control

Bandwidth Control Status : Enable Disable

Apply

WAN Bandwidth Control Setup

Upload/Download Bandwidth Setting

Download Total Rate(kbit):

Upload Total Rate(kbit) :

Apply

LAN Bandwidth Control Setup

Name	Committed Rate (kbit)	Ceil Rate(kbit)	P/MAC Address	Rule type
------	-----------------------	-----------------	---------------	-----------

Step 2:

By default, **Bandwidth Control** is disabled. Select **Enable**, followed by clicking the **Apply** button.



Enable/Disable Bandwidth Control

Bandwidth Control Status : Enable Disable

Apply

TO CONFIGURE WAN BANDWIDTH CONTROL SETTING

The access point can allow you to limit the entire throughput by configuring the **Upload / Download Bandwidth Setting** option. These values should be set to a positive integer indicating the maximum number of kilobytes transferred per second that will be allowed. The value of zero means unlimited.

For example, if you configure the **Upload Total Rate** to be 640kb/sec (80KB/sec), then the access point will send out packets by this speed no matter how many clients/users are connected to it.

Step 1:

Under the **CONFIGURATION** command menu, click on **Bandwidth Control** to select **WAN Bandwidth Control Setup**.

Step 2:

The values for the **Download Total Rate** and **Upload Total Rate Bandwidth Control** are preset to zero. The value of zero indicates no limit and is the default. Key in the desired values, followed by clicking the **Apply** button.



WAN Bandwidth Control Setup

Upload/Download Bandwidth Setting

Download Total Rate(kbit):

Upload Total Rate(kbit) :

Apply

TO CONFIGURE LAN BANDWIDTH CONTROL SETTING

The access point can allow you to limit the LAN user's throughput by configuring the **Bandwidth Control Rule**.

Step 1:

Under the **CONFIGURATION** command menu, click on **Bandwidth Control** to select **LAN Bandwidth Control Setup**.

Step 2:

Click **Add** to create the bandwidth rule for LAN user.

LAN Bandwidth Control Setup

Name	Committed Rate(kbit)	Ceil Rate(kbit)	IP/MAC Address	Rule type
sampleRule	10	100	09-00-2B-01-00-00	DownLoad By MAC Address

Step 3:

Click **Add** to create the rule for LAN user's bandwidth control.

Add Bandwidth Control Entry

Bandwidth Control Rule

Rule Name :

Committed Rate(kbit) :

Ceil Rate(kbit) :

Rule type : ▼

IP/MAC Address :

This table describes the parameters that can be modified in the **Add Bandwidth Control Entry** page.

Parameters	Description
Rule Name	The rule describes the type of bandwidth traffic to be controlled and of a specification of what action to take when that bandwidth traffic is encountered.
Committed Rate (kbit)	This is the minimum bandwidth rate at which a user can get the throughput.
Ceiling Rate (kbit)	This is the capped bandwidth rate to limit a user's throughput.
Rule Type	This is the type of rule depending on which IP or MAC address to use to download or upload a user's throughput.
IP/MAC Address	This is the type of address to be chosen depending on the rule type. For instance, if you may want to limit an entire machine address or a user by his router's MAC address, you can specify the MAC address using that field in the same way that you can limit by IP address.

Step 3:

After you have completed the parameters, click **Add** so that the new rule is added in the entry list shown in **Step 1**. To add more new bandwidth rules, repeat Step 1 through 3.



NOTE

The sum of **Committed Rate** of the rules should never exceed the corresponding **Total Rate**.

REMOTE MANAGEMENT

(only supported by Wireless Routing Client and Gateway)

The advanced network administrator will be delighted to know that remote management is supported on the access point. With this feature enabled, you will be able to access the access point's web-based configuration pages from anywhere on the Internet and manage your home/office network remotely.

TO SET UP REMOTE MANAGEMENT

Only two simple steps are required to set up remote management for the access point.

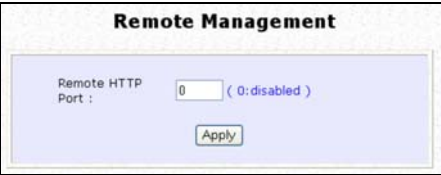

Step 1:
Under the **CONFIGURATION** command menu, click on **Remote Management**, and you will be brought to the following screen.

Step 2:
To disable Remote Management, just enter 0 for **Remote Http Port** .

To enable **Remote Management**, enter a port number that is not being used by other applications in the network. Please take note that it is recommended not to use port number 80 as it is blocked by some ISPs.

In Gateway mode **Remote Management** is enabled with Port 88. and the Ethernet port becomes a WAN port. To continue using the Ethernet port simply open the web manager using the WAN IP with Port 88.
Example: For WAN IP 100.100.100.1 use http://100.100.100.1:88



NOTE

In view of preventing unauthorized management from a remote location, please remember to replace the default password with a new one.

You are also advised to change this password from time to time to guard against malicious attackers.

PARALLEL BROADBAND

(only supported by Gateway)

The access point is equipped with the exclusive Parallel Broadband technology to provide scalable Internet bandwidth with Load Balancing and Fail-Over Redundancy.

By installing multiple units of the access point cascaded using Parallel Broadband, you may balance the Internet traffic generated from your private network over multiple broadband connections - providing the network with aggregated bandwidth! In the event of a particular broadband connection failing, the access point in cascade will use the remaining functional broadband channels, giving you an added peace of mind with its Fail-Over Redundancy capability.

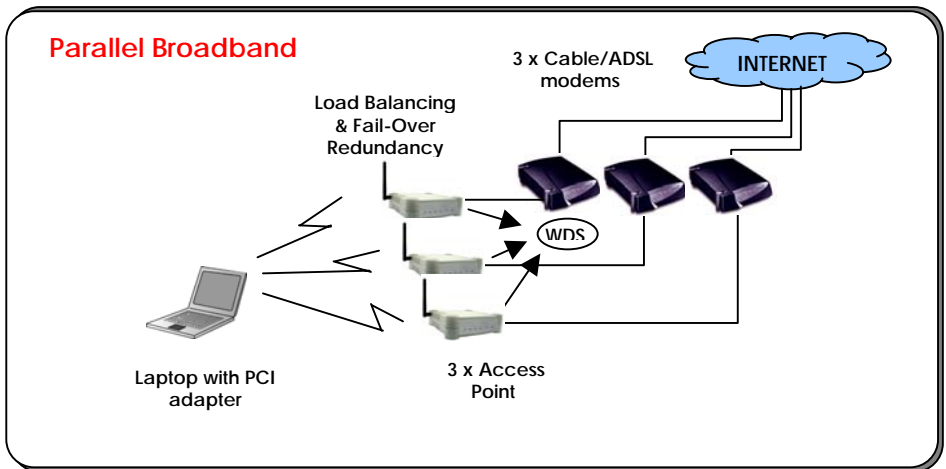

To implement Parallel Broadband, you will need to install two or more access points in the network, each connected to its broadband Internet service account. There is no restriction to the type of broadband Internet accounts they are connected to (whether Cable or ADSL). You may thus have one Access point connected to Cable Internet, and another to an ADSL line. When these access points operate in the Gateway mode using Parallel Broadband, you need to configure them by firstly enabling Parallel Broadband, thus enabling the WDS, and finally setting these access points to the same ESSID.

To learn more about Parallel Broadband, please read the whitepaper at www.cpx.com or www.compex.com.sg.

TO ENABLE PARALLEL BROADBAND ON WP54AG

Before you begin, ensure that each of the access point within the network is properly configured to connect to its individual broadband Internet account. Then ensure that either:

- each access point is connected to an Ethernet port in the network as illustrated above or
- the access points are interconnected by WDS or
- the access points are wired to each other.

Finally, you are ready to access the web-based configuration of each of your access point to enable the Parallel Broadband feature. You will have to enable all the DHCP servers in all access points before enabling Parallel Broadband. Please note that you need to interconnect all access points

Step 1:

Under the **CONFIGURATION** command menu, click on **Parallel Broadband**.

Step 2:

Next simply select **Enable** and click the **Apply** button to make the changes effective.

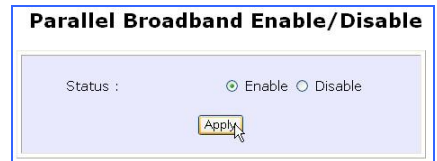

Step 3:

Repeat this for the other access points in your network and they will communicate with each other and assign each new user to the access point that has the smallest load, so that there is approximately the same number of users on each access point.



Important:

If you have only one unit of the access point, you DO NOT need to implement the Parallel Broadband feature for broadband Internet sharing.

EMAIL NOTIFICATION

The access point provides this feature to notify you by email when there is a change in the WAN IP address that was supplied to you earlier.

The screenshot shows the 'WAN PPPoE Setup' configuration page. The 'WAN Type' is set to 'PPPoE'. The 'Username' is 'guest' and the 'Password' field is empty. The 'Status' is 'Connecting'. At the bottom, there are three buttons: 'Apply', 'Email Notification', and 'Help'. A mouse cursor is pointing at the 'Email Notification' button.

Step 1:

Under the **CONFIGURATION** command menu, click on **WAN PPPoE Setup** or **WAN PPTP Setup**, and you will be brought to the following screen.

Step 2:

Click on the **Email Notification** button.

The screenshot shows the 'Email Notification' configuration page. The 'Email Notification' is set to 'Enable'. The 'Email address of Receiver' is 'mail@yahoo.com'. The 'IP address of Mail Server' is '192.168.88.43' with a checked 'Needs Authentication' box. The 'User Name' is 'sampleUser' and the 'Password' is masked with dots. The 'Email address of Sender' is 'send@yahoo.com'. At the bottom, there are three buttons: 'Apply', 'Back', and 'Refresh'.

Step 3:

Click on the **Enable** button and key in the following fields as described below:

- **Email address of Receiver:**

This is the email address of the receiver to whom the message would be sent.

- **IP address of Email Server:**

This is the IP address of the SMTP server through which the message would be sent out. (Take note that you are encouraged to use your ISP's SMTP server).

- **User Name:**

This is the mail account user's name that should be entered if authentication is required.

- **Password:**

This is the mail account user's password that should be entered if authentication is required.

- **Email address of Sender:**

This is the email address of the sender from whom the message will appear to come.

Step 4:

By default, the checkbox next to **Needs Authentication** is not ticked. This option allows you to specify whether the SMTP server requires authentication.

Step 5:

Then click on the **Apply** button.

STATIC ADDRESS TRANSLATION

(only supported by Wireless Routing Client and Gateway)

If you use a notebook for work at the office, it is probable that you also bring it home to connect to the Internet and retrieve emails or surf the web. Since it is most likely that your office's and your home's broadband-sharing network subnets are differently configured, you would have to struggle with reconfiguring your TCP/IP settings each time you use the notebook in a different place. The access point provides the Static Address Translation (SAT) feature to enable its users to bypass this hassle.

Let's say that the IP address of your notebook is set to 203.120.12.47 at the workplace but the access point that is connecting your home network to the Internet, is using an IP address of 192.168.168.1. You have enabled SAT on your router and want to access the Internet without changing the IP address of the notebook as you have to use it at work again on the next day.

Since it is still set to the TCP/IP settings used in your office, the notebook will then try to contact the IP address of your office's gateway to the Internet. When the access point finds that the notebook is trying to contact a device that lies in a different subnet from that of the home network, it would then inform the notebook that the gateway to the Internet is in fact itself (Access Point).

Once the notebook has been informed that the gateway to the Internet is the access point, it will contact the latter (Access Point) to access the Internet, without any change to its TCP/IP settings required.



NOTE

For SAT to function properly:

1. The IP address of the notebook should belong to a different subnet from the LAN IP address of your access point.
 2. The <Default Gateway> in the TCP/IP settings of your notebook should NOT be left blank.
-

Step 1:

Under the **Home User Features** command menu, click on **Static Address Translation**.

Step 2:

You may then choose to **Enable** or **Disable** Static Address Translation here, followed by clicking the **Apply** button. (Note: SAT is disabled by default)



DNS REDIRECTION

(only supported by Wireless Routing Client and Gateway)

When you enter a URL in your Internet browser, the browser requests for a name-to-IP address translation from the Domain Name System (DNS) servers to be able to locate the web server

The DNS server, in turn, looks for the answer in its local cache and if an appropriate entry is found, sends back this cached IP address to the browser. Otherwise, it would have to contact other DNS servers until the query can be resolved.

When you enable the DNS Redirection feature, DNS requests from the LAN clients will be processed by Access point. Unless in the access point's LAN Setup you have already assigned a specific DNS server that should always be used, the access point would contact the DNS server allocated by your ISP to resolve DNS requests.

When DNS Redirection is enabled, the DNS server used by the access point would override the one defined in the TCP/IP settings of the LAN clients. This allows the access point to direct DNS requests from the LAN to a local or to a closer DNS server it knows of, thus improving response time.

The DNS Redirection feature also provides better control to the network administrator. In case of a change in DNS servers, the latter can just indicate the IP address of the actual DNS server in the access point's LAN Setup and enable DNS Redirection, without having to re-configure the DNS settings of each LAN client.

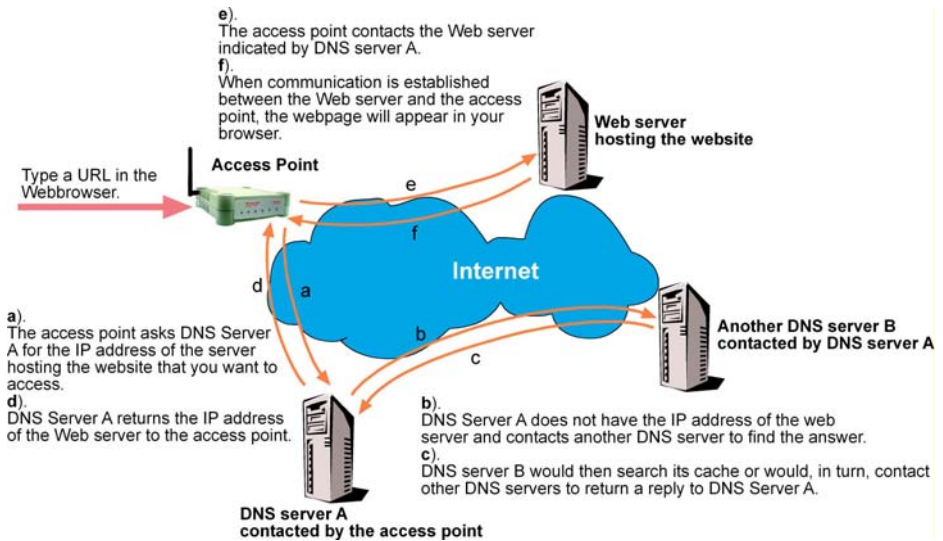

NOTE

For Internet access, please do NOT leave the DNS Server field of the PC's TCP/IP Properties blank. Simply key in any legal IP address for it (e.g. 10.10.10.10) even though you do not have the exact DNS IP address.

TO ENABLE/DISABLE DNS REDIRECTION

Step 1:

Under the **Home User Features** command menu, click on **DNS Redirection**.

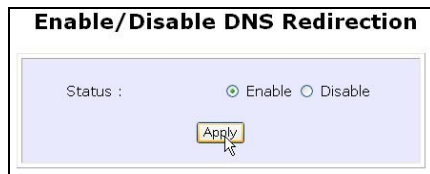

Step 2:

Simply choose **Enable** or **Disable** for the **Status** of **DNS Redirection**.

Step 3:

Complete the setup by clicking the **Apply** button.

DYNAMIC DNS SETUP

It is difficult to remember the IP addresses used by computers to communicate on the Internet. It gets even more complicated when ISPs change your public IP address regularly, as is the case when the Internet connection type is Dynamic IP or PPPoE with Dynamic IP.

If you are doing some web hosting on your computer and are using Dynamic IP, Internet users would have to keep up with the changing IP address before being able to access your computer.

When you sign up for an account with a Dynamic Domain Name Service (DDNS) provider, the latter will register your unchanging domain name, e.g. **MyName.Domain.com**. You can configure your access point to automatically contact your DDNS provider whenever the access point detects that its public IP address has changed. The access point would then log on to your account and update it with its latest public IP address.

If someone types in your address: **MyName.Domain.com** into their web browser, this request would go to the DDNS provider which would then re-direct that request to your computer, no matter what IP address it has been currently assigned by your ISP.

TO ENABLE/DISABLE DYNAMIC DNS SETUP

Step 1:

Under the **Home User Features** command menu, click on **Dynamic DNS Setup**.

Step 2:

You may then choose to **Enable** or **Disable** Dynamic DNS here, followed by clicking the **Apply** button. (Note: Dynamic DNS is disabled by default)



TO MANAGE DYNAMIC DNS LIST

Step 1:

Under the **Home User Features** command menu, click on **Dynamic DNS Setup**.

Step 2:

If you have already created a list earlier, click on the **Refresh** button to update the list.



Step 3:

To add a new Dynamic DNS to the list, click on the Add button and you will see the **Choice DDNS Provider** page appear. There are two default providers that you can use. The following parameters are explained below:

- **Choice :**

This allows you to check the radio button of your preferred DDNS provider.

- **Provider Name :**

This is the name of your preferred DDNS provider.

- **Register Now :**

This allows you to go to the website of your preferred DDNS provider where you can register your account.

Choice	Provider Name	Register Now
<input type="radio"/>	2MyDNS - Dynamic DNS Service Provider	Register Online
<input type="radio"/>	DDNS	Register Online

Next Back

There are two DDNS providers that are pre-defined for you. Please note that you need to be connected to the Internet to register your DDNS account.

To select **2MyDNS – Dynamic DNS Service Provider** as DDNS Service Provider

Step 1:

Under the **Choice** column in the **Choice DDNS Provider** check the radio button next to the **2MyDNS – Dynamic DNS Service Provider**. Then click on the **Next** button to proceed.

Choice	Provider Name	Register Now
<input checked="" type="radio"/>	2MyDNS - Dynamic DNS Service Provider	Register Online
<input type="radio"/>	DDNS	Register Online

Next Back

Step 2:

Enter your **Domain Name**.

Step 3:

The **Auto Detect** checkbox is ticked by default. The **WAN IP** entry box is blank by default. These default settings should be applied if the

Provider : 2MyDNS - Dynamic DNS Service Provider

Domain Name :

WAN IP : Auto Detect

Username :

Password :

Wildcard : YES NO

Mail Exchanger :

Backup Mail Exchanger : YES NO

Add Reset Back

dynamic WAN IP connection is used.

For instance,

If your ISP connection service uses the dynamic WAN IP, tick the **Auto Detect** checkbox to let the DDNS server learn your current WAN IP address. Enter your DDNS account **Username** and **Password**.

However, if you are using a fixed WAN IP connection, enter the IP address in the **WAN IP** field. Then, un-tick the **Auto Detect** checkbox. Then the access point will update the DDNS server using that WAN IP entered in its field.

Step 4:

(Optional) If you enable the wildcard service, your hostname would be allowed multiple identities.

For example, if you register: **mydomain.2mydns.net**, users looking for www.mydomain.2mydns.net or ftp.mydomain.2mydns.net can still reach your hostname.

Step 5:

(Optional) In the Mail Exchanger field, enter the Static WAN IP address of the mail server configured to handle email for your domain. Select **Backup Mail Exchanger** to enable this service.

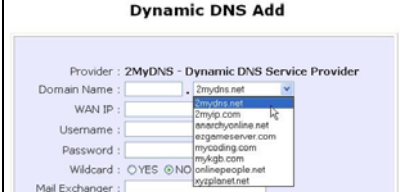

The screenshot shows a web form titled "Dynamic DNS Add". The form contains the following fields and options:

- Provider: 2MyDNS - Dynamic DNS Service Provider
- Domain Name: [text input]
- WAN IP: [text input]
- Username: [text input]
- Password: [text input]
- Wildcard: YES NO
- Mail Exchanger: [text input]

A dropdown menu is open for the Domain Name field, showing a list of domain providers including 2mydns.net, 2myip.com, anarchyonline.net, e2gameserver.com, my4gb.com, onlinepeople.net, and localnet.net. A mouse cursor is pointing at 2myip.com.

Step 6:

Click on the Add button to save the new addition.

Step 7:

The new domain is added to the Dynamic DNS list table.



Step 8:

It will appear as a hyperlink that you can click to go back to the Dynamic DNS Edit page. From this page, you can update any of the parameters, delete the domain name or reset all parameters to be blank again.

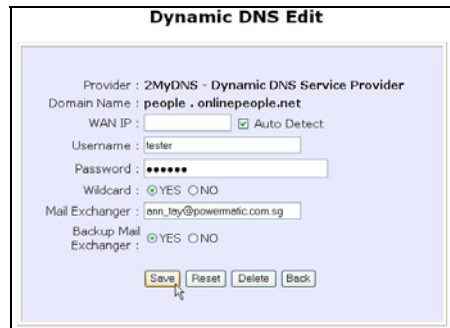

To select **DtDNS** as DDNS Service Provider

Step 1:

Under the **Choice** column in the table of **Choice DDNS Provider** check the radio button next to the **DtDNS**. Then click on the **Next** button to proceed.

Choice	Provider Name	Register Now
<input type="radio"/>	2M/DNS - Dynamic DNS Service Provider	Register Online
<input checked="" type="radio"/>	DtDNS	Register Online

Next Back

Step 2:

Enter your **Domain Name**.

Step 3:

The **Auto Detect** checkbox is ticked by default. The **WAN IP** entry box is blank by default. These default settings should be applied if the dynamic WAN IP connection is used.

Provider : DtDNS

Domain Name : .

WAN IP : Auto Detect

Password :

Add Reset Back

For instance,

If your ISP connection service uses the dynamic WAN IP, tick the **Auto Detect** checkbox to let the DtDNS server learn your current WAN IP address. Enter your DtDNS account **Username** and **Password**.

However, if you are using a fixed WAN IP connection, enter the IP address in the **WAN IP** field. Then, un-tick the **Auto Detect** checkbox. Then the access point will update the DtDNS server using that WAN IP entered in its field.

Step 4:

Then click on the **Add** button.

Step 5:

In our example, while the new domain name, **cool.3d-game.com** is being added to the list, the message 'Waiting in queue...' will be displayed under the **Update Status** column of the **Dynamic DNS List** table.



Chapter 8: Security Configuration

This chapter describes the security configuration mainly found in the **Wireless Routing Client** and **Gateway** modes.

PACKET FILTERING

As part of the comprehensive security package found on the access point, you may perform IP packet filtering to selectively allow/disallow certain applications from connecting to the Internet.

TO CONFIGURE PACKET FILTERING

Step 1:

Under the **Security Configuration** command menu, click on **Packet Filtering**.



Step 2:

You must first choose the **Packet Filter Type** by clicking on the **Change** button.

Step 3:

Select from three choices: **Disabled**, **Sent**, **Discarded**, and then click on the **Apply** button. The default is **Disabled**, which allows all packets to be sent.

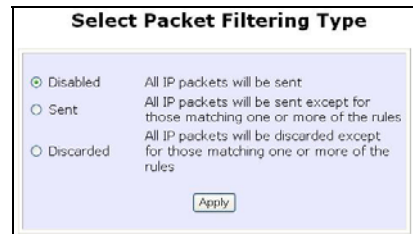

Packet Filter Configuration

Packet Filter Type : **Sent**

Rule Name	IP Address(es)	Destination Port(s)	Day of the week	Time of the Day

Add a new Packet Filter rule

Rule Name :

IP Address : **Any**

From : 192.168.168.

To : 192.168.168.

Destination Port : **Any**

From :

To :

Day of the Week : **Any**

From : **Mon**

To : **Fri**

Time of the Day : **Any** (hh: 00-23, mm: 00-59)

From : (hh:mm)

To : (hh:mm)

Step 4:

Click on the **Add** button and you will be able to define the details of your **Packet Filter Rule** from the screen on the right.

4a). Enter **Rule Name** for this new packet filtering rule. For example, *BlockCS*

Rule Name :

4b). From the **IP Address** drop down list, select whether to apply the rule to:

- A **Range** of IP addresses
In this case, you will have to define **(From)** which IP address **(To)** which IP address, your range extends.

IP Address : **Range**

From : 192.168.168. 25

To : 192.168.168. 75

- A **Single** IP address
Here, you need only specify the source IP address in the **(From)** field.

IP Address : **Single**

From : 192.168.168. 25

To : 192.168.168.

- **Any** IP address
You may here, leave both, the **(From)** as well as the **(To)** fields, blank. Here, the rule will apply to all IP addresses.

IP Address : **Any**

From : 192.168.168.

To : 192.168.168.

4c). At the **Destination Port** drop down list, select either:

Destination Port : **Range**

From : 21

To : 81

- A **Range** of TCP ports
In this case, you will have to define **(From)** which port **(To)** which port, your rule applies.

Destination Port : **Single** ▾
From : 25
To :

- A **Single** TCP port
Here, you need only specify the source port in the **(From)** field.

Destination Port : **Any** ▾
From :
To :

- **Any** IP port
You may here, leave both, the **(From)** as well as the **(To)** fields, blank. Here, the rule will apply to all ports.

Day of the Week : **Range** ▾
From : **Wed** ▾
To : **Fri** ▾

4d). From the **Day of the Week** drop down list, select whether the rule should apply to:

- A **Range** of days
Here, you will have to select **(From)** which day **(To)** which day

Day of the Week : **Any** ▾
From : **Sun** ▾
To : **Sun** ▾

- **Any** day
In this case, you may skip both the **(From)** as well as the **(To)** drop down fields.

Time of the Day : **Range** ▾ (hh: 00-23, mm: 00-59)
From : 08:00 (hh:mm)
To : 21:30 (hh:mm)

4e). At the **Time of the Day** drop down list, you may also choose to apply the rule to:

- A **Range** of time
In which case, you have to specify the time in the format **HH:MM**, where **HH** may take any value from 00 to 23 and **MM**, any value from 00 to 59.

Time of the Day : **Any** ▾ (hh: 00-23, mm: 00-59)
From : (hh:mm)
To : (hh:mm)

- **Any** time

Here, you may leave both **(From)** and **(To)** fields blank.

Step 5:

Click on the **Apply** button to make the new rule effective.

The **Filtering Configuration** table will then be updated.

Add a new Packet Filter rule

Rule Name :

IP Address :

From : To :

Destination Port :

From : To :

Day of the Week :

From : To :

Time of the Day : (hh: 00-23, mm: 00-59)

From : (hh:mm) To : (hh:mm)

Step 6:

In this example, let us say we would like to block an application called CS from all PCs (any IP address within the network) from Monday to Friday 7am to 6pm, and this application is using the port number 27015.

Therefore, for a rule we name BlockCS, and add the entries depicted on the left. Clicking on the **Add** button will make your packet filter rule effective.

URL FILTERING

The access point supports URL Filtering, which allows you to easily set up rules to block objectionable web sites from your LAN users.

TO CONFIGURE URL FILTERING

Step 1:

Under the **Security Configuration** command menu, click on **URL Filtering**.



Step 2:

You may now define the **URL Filter Type** by clicking the **Change** button.

Step 3:

Select **Block** or **Allow**, and then click on the **Apply** button. The default is **Disabled**, which allows all websites to be accessed.



When you will be returned to the page shown above, then click the **Add** button.



Step 4:

For the **Host Name** field, input the web site address that you wish to block. Then click the **Add** button to complete your setup.

FIREWALL CONFIGURATION

More than just a "NAT" firewall, there is a powerful Stateful Packet Inspection (SPI) firewall option that can be activated on the access point. Stateful inspection compares certain key parts of the packet to a database of trusted information before allowing it through. Common hacker attacks like IP Spoofing, Port Scanning, Ping of Death and SynFlood can be easily thwarted with Compex's SPI firewall.

To learn more about SPI firewall, read our whitepaper at www.cpx.com or at www.compex.com.sg.

TO CONFIGURE SPI FIREWALL

The following steps explain the configuration of Compex's SPI firewall. As incorrect configuration to the firewall can result in undesirable network behavior, you are advised to carefully plan your firewall security rules.

Step 1:

Under the **Security Configuration** command menu, click on **Firewall Configuration**.

Step 2:

First, enable the firewall. You can choose among the **Default Low**, **Default Medium** or **Default High** security options for convenient setup.

Step 3:

Then you may choose the type of network activity information you wish to log for reference. Data activity arising from different types of protocol can be recorded.

Firewall Configuration

Warning: Incorrect configuration may cause undesirable behavior.

Firewall Status: Enable Disable

Allow user visit LAN from WAN port

Log Information

Accepted: TCP Packets UDP Packets
 ICMP Packets IGMP Packets

Denied: TCP Packets UDP Packets
 ICMP Packets IGMP Packets

No	Active	Name	Disposition Policy	Protocols	Source Address(es)	Destination Address(es)	Source Ports	Destination Ports
0	<input type="checkbox"/>	ICMP-DENY	Deny	ICMP	Any	Any	Any	Any
1	<input type="checkbox"/>	TCP-DENY	Deny	TCP	Any	Any	Any	Any
2	<input checked="" type="checkbox"/>	icmp	Accept	ICMP	Any	Any	Any	Any
3	<input checked="" type="checkbox"/>	ftp	Accept	UDP	Any	Any	53	Any
4	<input checked="" type="checkbox"/>	ftp (00-52)	Accept	TCP	Any	Any	Any	80-83
5	<input checked="" type="checkbox"/>	ftp (8000)	Accept	TCP	Any	Any	Any	8000
6	<input checked="" type="checkbox"/>	cdp	Accept	UDP	Any	Any	1645	Any
7	<input checked="" type="checkbox"/>	ftp (00-80)	Accept	UDP	Any	Any	81	88

Add Apply

Default Low Default Medium Default High

Step 4:

You may add more firewall rules for specific security purposes. Click on the **Add** radio button at the screen shown above, followed by the **Edit** button and the screen on the left will appear.

Edit Firewall rule

Rule Number : 7
Rule Name : dhcp-bootp
Disposition Policy : Accept
Protocols : Udp

ICMP Types

- All Types
- Destination Unreachable
- Redirect
- Time Exceeded
- Timestamp Request
- Information Request
- Address Mask Request

- Echo Reply
- Source Quench
- Echo Request
- Parameter Problem
- Timestamp Reply
- Information Reply
- Address Mask Reply

Source IP Address : Any
(From) :
(To) :

Destination IP Address : Any
(From) :
(To) :

Source Port : Single
(From) : 67
(To) :

Destination Port : Single
(From) : 68
(To) :

Check Options : LSRR
Check TTL :
TTL value :

Save Delete Cancel

- Rule Name** : Enter a unique name to identify this firewall rule.
- Disposition Policy** : This parameter determines whether the packets obeying the rule should be accepted or denied by the firewall. Choose between Accept and Deny.
- Protocols** : Users are allowed to select the type of data packet from: TCP, UDP, ICMP, IGMP or ALL.
- Note: If users select either ICMP or IGMP, they are required to make further selection in the ICMP Types or IGMP Types respectively.
- ICMP Types** : This IP protocol is used to report errors in IP packet routing. ICMP serves as a form of flow control, although ICMP messages are neither guaranteed to be received or transmitted.

ICMP Packet Type	Description
Echo request	Determines whether an IP node (a host or a router) is available on the network.
Echo reply	Replies to an ICMP echo request.
Destination unreachable	Informs the host that a datagram cannot be delivered.
Source quench	Informs the host to lower the rate at which it sends datagrams because of congestion.
Redirect	Informs the host of a preferred route.
Time exceeded	Indicates that the Time-to-Live (TTL) of an IP datagram has expired.
Parameter Problem	Informs that host that there is a problem in one the ICMP parameter.
Timestamp Request	Information that is from the ICMP data packet.
Information Request	Information that is from the ICMP data packet.
Information Reply	Information that is from the ICMP data packet.

IGMP Types : This IP protocol is used to establish host memberships in particular multicast groups on a single network. The mechanisms of the protocol allow a host to inform its local router, using Host Membership Reports.

Host Membership Report	Information that is from the IGMP data packet.
Host Membership Query	Information that is from the IGMP data packet.
Leave Host Message	Information that is from the ICMP data packet.

Source IP : This parameter allows you to specify workstation(s) generating the data packets. Users can either set a single IP address or set a range of IP addresses.

Destination IP : This parameter lets you specify the set of workstations that receive the data packets. Users can either set a single IP address or set a

range of IP addresses.

Source Port : You can control requests for using a specific application by entering its port number here. Users can either set a single port number or a range of port numbers.

Destination Port : This parameter determines the application from the specified destination port. Users can either set a single port number or a range of port numbers.

Check Options : This parameter refers to the options in the packet header. The available selection options are abbreviated as follows:

SEC – Security
LSRR – Loose Source Routing
Timestamp – Timestamp
RR – Record Route
SID – Stream Identifier
SSRR – Strict Source Routing
RA – Router Alert

Check TTL : This parameter would let you screen packets according to their Time-To-Live (TTL) value available options are:

1. Equal
2. Less than
3. Greater than
4. Not equal

FIREWALL LOGS

When the access point's SPI firewall is in operation, valuable traffic patterns in your network will be captured and stored into the Firewall Logs. From these logs, you can extract detailed information about the type of data traffic, the time, the source and destination address/port as well as the action taken by the SPI firewall. You can choose which type of packets to log from the **Firewall Configuration**.

TO VIEW FIREWALL LOGS

Step 1:

Under the **SECURITY CONFIGURATION** command menu, click on **Firewall Logs**.

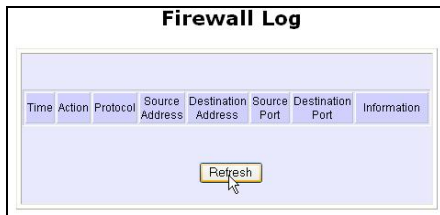

Step 2:

Click the **Refresh** button to see new information captured in the log.

Chapter 9: System Utilities

USING THE SYSTEM TOOLS MENU

PING UTILITY

This feature lets you determine whether your access point can communicate (ping) with another network host. This feature is available only for the **Wireless Routing Client** and **Gateway** modes.

Step 1:

Select **Ping Utility** under the **SYSTEM TOOLS** command menu.

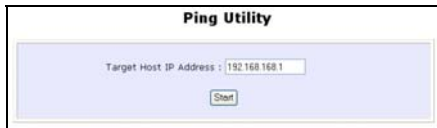

Step 2:

Enter the IP address of the target host where the target host you want the access point to ping to.

Step 3:

To ping the access point, click **Start**.

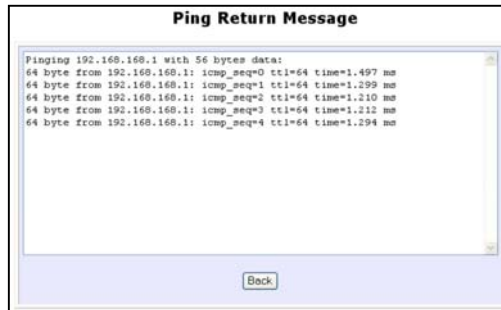

Step 4:

The Ping messages will be displayed.

SYSLOG

Syslog allows remote system logging.
You can setup **Syslog** with the following steps.

Step 1:

Click on **Syslog** from the **SYSTEM TOOLS** menu.



Step 2:

Select to **Enable Syslog**.

Step 3:

Enter the **Remote IP Address or Domain Name**

Step 4:

Enter the **Remote Port**

Step 5:

Click **Apply** to make the changes.

A screenshot of a web form titled "System Log Setup". The form has a light blue background and contains the following elements: a "Status" section with "Enable" selected (radio button) and "Disable" unselected; a "Remote IP Address or Domain Name" text input field containing "192.168.168.1"; a "Remote Port" text input field containing "514"; and an "Apply" button at the bottom center.

SYSTEM IDENTITY

If your network operates with several access points, you would find it useful to have a means of identifying each individual device.

You can define the **System Identity** of your access point to be uniquely identifiable as follows:

Step 2:

Click on **System Identity** from the **SYSTEM TOOLS** menu.

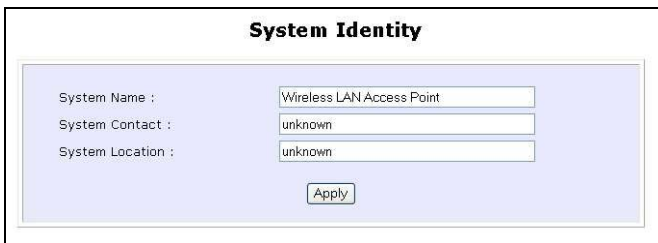

The screenshot shows a window titled "System Identity" with a light blue background. It contains three text input fields and an "Apply" button. The fields are labeled "System Name :", "System Contact :", and "System Location :". The values entered in the fields are "Wireless LAN Access Point", "unknown", and "unknown" respectively.

Field Label	Value
System Name :	Wireless LAN Access Point
System Contact :	unknown
System Location :	unknown

Apply

Step 6:

Enter a unique name in the **System Name** field.

Step 7:

Fill in the name of a person to contact in the **System Contact** field.

Step 8:

Fill up the **System Location** field. If there are multiple devices in your network or building, this entry might help to identify the device location.

Step 9:

Click on the **Apply** button to effect the changes.

SYSTEM CLOCK SETUP

Step 1:

Click on **System Clock Setup** from the **SYSTEM TOOLS** menu.

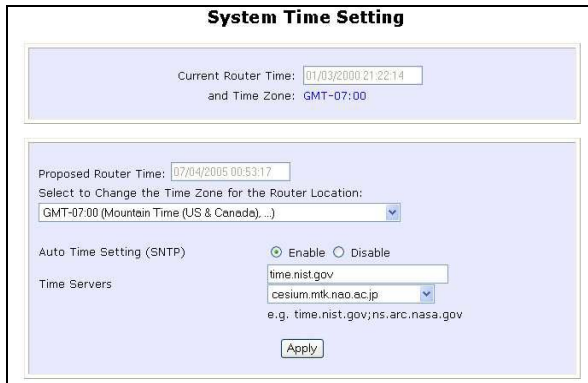

The screenshot shows the 'System Time Setting' configuration page. At the top, it displays the 'Current Router Time' as 01/03/2000 21:22:14 and the 'Time Zone' as GMT-07:00. Below this, the 'Proposed Router Time' is shown as 07/04/2005 00:53:17. A section titled 'Select to Change the Time Zone for the Router Location:' contains a drop-down menu currently set to 'GMT-07:00 (Mountain Time (US & Canada)...)' with a small downward arrow. Underneath, the 'Auto Time Setting (SNTP)' section has two radio buttons: 'Enable' (which is selected) and 'Disable'. Below the radio buttons is a text input field for 'Time Servers' containing 'time.nist.gov'. A second drop-down menu is open below this field, showing 'cesium.mtk.nao.ac.jp' as the selected option. Below the drop-down menu, there is a small text example: 'e.g. time.nist.gov;ns.arc.nasa.gov'. At the bottom of the form is an 'Apply' button.

Step 2:

Select the appropriate time zone from the **Select to Change the Time Zone for the Router Location** drop-down list.

Step 3:

Enable the Auto Time Setting (SNTP) radio button. **SNTP** stands for Simple Network Time Protocol and is used to synchronise computer clocks.

Step 4:

Fill in the **Time Servers** field and click on the **Apply** button to effect the changes.

FIRMWARE UPGRADE

Keep your access point updated with the latest capabilities by downloading its latest firmware revision from either of Compex's corporate web sites at www.compex.com.sg or www.cpx.com before following the next steps. You can check the types and version of your firmware by clicking on **About System** from the **HELP** menu.

To begin with, ensure that you have downloaded the latest firmware onto your local hard disk drive.

Step 1:

Click on **Firmware Upgrade** from the **SYSTEM TOOLS** menu.



Step 2:

Click on the **Browse** button to locate the file.

Step 3:

Click on the **Upgrade** button.

Follow the instructions given during the upgrading process.



Step 4:

You need to reboot the system after the firmware upgrade.



NOTE

The firmware upgrade process must NOT be interrupted otherwise the device might become unusable.

BACKUP OR RESET SETTINGS

You may choose to save the current configuration profile, to make a backup of it onto your hard disk, to restore an earlier profile saved on file or to reset the access point back to its default settings.

RESET YOUR SETTINGS

Step 1:

Click on **Backup or Reset Settings** from the **SYSTEM TOOLS** menu.

Step 2:

To discard configurations made and restore the access point to its initial factory settings, click on **Reset** button.

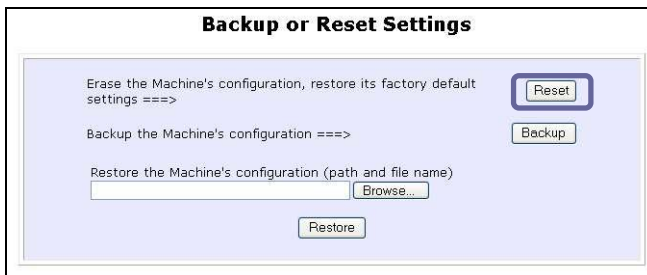

The screenshot shows a dialog box titled "Backup or Reset Settings" with a light blue background. It contains three options, each with a corresponding button:

- The first option is "Erase the Machine's configuration, restore its factory default settings ==>". To its right is a button labeled "Reset", which is highlighted with a blue border.
- The second option is "Backup the Machine's configuration ==>". To its right is a button labeled "Backup".
- The third option is "Restore the Machine's configuration (path and file name)". Below this text is a text input field and a "Browse..." button. Below the input field is a button labeled "Restore".

Step 3:

The system will prompt you to reboot your device. Click on the **Reboot** button to proceed.

BACKUP YOUR SETTINGS

Step 1:

Click on **Backup or Reset Settings** from the **SYSTEM TOOLS** menu.

Step 2:

If you want to back up the current settings of your access point onto your hard disk drive, click on the **Backup** button.

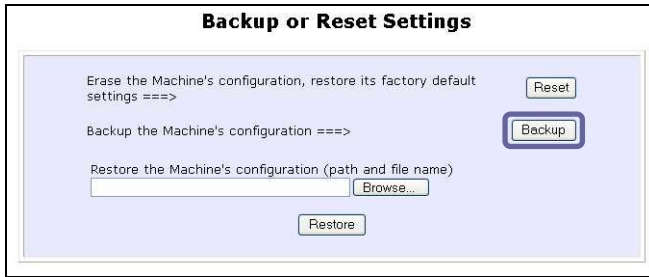

Step 3:

Next, save your configuration file to your local disk.



RESTORE YOUR SETTINGS

Step 1:

Click on **Backup or Reset Settings** from the **SYSTEM TOOLS** menu.

Step 2:

If you want to store back the settings that you had previously saved, click on the **Browse...** button. Proceed to the folder where you saved your configuration file.

Backup or Reset Settings

Erase the Machine's configuration, restore its factory default settings ==>>

Backup the Machine's configuration ==>>

Restore the Machine's configuration (path and file name)

Click on the **Restore** button and the system will prompt you to reboot your device.

REBOOT SYSTEM

Most of the changes you make to the system's settings require a system reboot before the new parameters can take effect.

Step 1:

Click on **Reboot System** from the **SYSTEM TOOLS** menu.

Step 2:

Click on the **Reboot** button.

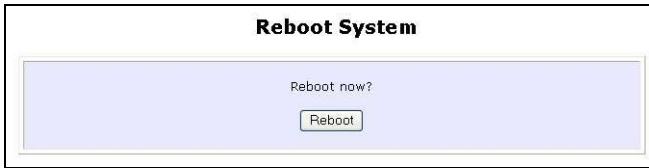

Step 3:

Wait for the system to reboot and the login page will be displayed.



CHANGE PASSWORD

It is recommended that you change the default login password, which is case sensitive and is set by default, to **password**.

Step 1:

Click on **Change Password** from the **SYSTEM TOOLS** menu.

Step 2:

Key in the **Current Password**. The factory default is *password*.

Enter the **new password** in the **New Password** field as well as in the **Confirm Password** field.

Step 3:

Click on the **Apply** button to update the changes.



The screenshot shows a web form titled "Change Password". It contains three input fields: "Current Password:", "New Password:", and "Confirm Password:". Each field is filled with a series of dots representing masked text. Below the fields is a yellow "Apply" button.

Change Password	
Current Password:
New Password:
Confirm Password:
<input type="button" value="Apply"/>	

LOGOUT

To exit the Web interface, follow the next few steps.

Step 1:

Click on **Logout** from the **SYSTEM TOOLS** menu.

Step 2:

Click the **LOGIN!** button to access your access point's configuration interface again.

Wireless LAN Access Point Management



Please enter your password:

[[Forgot your password?](#) - see the User's Guide for instructions]

USING THE HELP MENU

GET TECHNICAL SUPPORT

This page presents the contact information of Compex's technical support centres around the world.

Step 1:

Click on **Get Technical Support** from the **HELP** menu.

Support Information

For technical support email to: support@compex.com.sg
For updates connect to the following Web Sites:
<http://www.cpx.com>
<http://www.compex.com.sg>

Regional Technical Support Centers

U.S.A., Canada, Latin America and South America :

Compex Inc.
840 Columbia Street, Suite B, Brea, CA92821,USA
Tel : (714) 482-0333
Fax : (714) 482-0332
800 Line: (800) 279-8891
Support email: support@cpx.com

Asia, Australia, New Zealand, Middle East and the rest of the world :

Compex Systems Pte. Ltd.
135, Joo Seng Road, #08-01,
PM Industrial Building
Singapore 368363
HotLine : (65) 6-286-1805
Fax : (65) 6-283-8337

The access point is a feature-packed device. If you require further information than provided in the manual or data sheet, please contact one of Compex's Technical Support Centres by mail, email, fax or telephone.

ABOUT SYSTEM

The **About System** page displays a summary of your system configuration information. Support technicians might require specific information about your system data when they are troubleshooting your configuration. You can use the information displayed in this page to quickly find the data they need to resolve your system problem.

Step 1:

Click on **About System** from the **HELP** menu.

The **System Information** page will supply information concerning your access point's configuration settings.

System Information

Device:

System Up Time :	0 Days 00:04:59
BIOS/Loader Version :	2.1f (build 0310)
Firmware Version :	1.43 (build 0628)
NetWork Mode :	Inherent Bridge

Wireless:

Hardware Address :	00-80-48-3d-0f-81
WLAN name (ESSID):	compex-wp54ag
Operating frequency :	5180MHz
Operating Channel :	36
Security Mode :	None

Management Port:

Hardware Address :	00-80-48-3d-0f-80
IP Address :	192.168.168.1
Network Mask :	255.255.255.0
DHCP Server :	Disabled

Appendix I: Firmware Recovery

This section demonstrates how to reload the firmware to the access point should the system fail to launch properly. In such cases, the access point will automatically switch to loader mode and the diagnostic LED will light up and remain ON.

The table below illustrates the behavior of the diagnostic LED (LED).

Access point State	Diagnostic LED (LED) State
Corrupted firmware – access point automatically switches to loader mode	Blinks very fast
Recovery in progress	ON
Successful recovery	Blinks very slowly

Before starting, check the status of the diagnostic LED against the table above to confirm whether firmware failure has occurred.

Step 1:

Power the access point off and disconnect it from the network.

Step 2:

Use a MDI cable to connect the LAN port of the access point to the LAN port of your computer.

Step 3:

Power the access point on, and then start up your computer. You are recommended to set your computer's IP address to 192.168.168.100 and its network mask to 255.255.255.0.

Step 4:

Insert the WP54AG Product CD into the CD drive of your computer.

Step 5:

From the **Start** menu, click **Run** and type **cmd**. When the command prompt window appears, type in the following command:

X:\recovery\TFTP -i 192.168.168.1 PUT image_name.IMG, where **X** refers to your CD drive and **image_name.IMG** to the firmware filename found in the Recovery folder of the Product CD.

Step 6:

If you have downloaded a newer firmware and have saved it in your local hard disk as: **C:\WP54AG\WP54Axxx.IMG**, then replace the command with this new path and firmware name. In our example:

C:\WP54AG\TFTP -i 192.168.168.1 PUT WP54Axxx.img

The recovery process will now take place. You can check the diagnostic LED to monitor the progress of the recovery process.

When firmware restoration has completed, reboot the access point and it will be ready to operate.

Appendix II: TCP/IP Configuration

Once the hardware has been set up, you need to assign an IP address to your PC so that it will be in the same subnet as the access point. By default, the access point's IP address is 192.168.168.1; and its subnet mask is 255.255.255.0. You need to configure your PC's IP address to 192.168.168.xxx; and its subnet mask is 255.255.255.0, where xxx can be any number from 2 to 254 excluding 1. Simply follow the procedures stated below to configure the TCP/IP settings of your PC.

FOR WINDOWS 95/98/98SE/ME/NT

Please note the following instructions are based on Windows 98.

Step 1:

From your desktop, right click **Network Neighborhood** icon and select **Properties**.

Step 2:

Choose the network adapter that you are using; right click and select **Properties**.

Step 3:

Highlight the **TCP/IP** and click on **Properties** button.

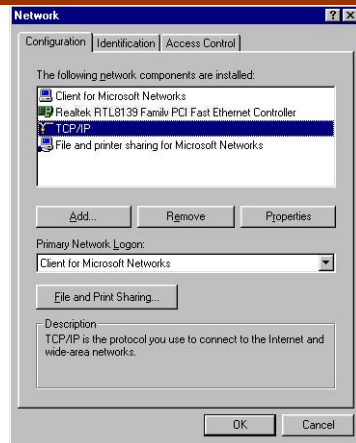

Step 4:

Select the radio button for **Specify an IP address**.

Enter the IP Address and Subnet Mask as 192.168.168.X and 255.255.255.0, where X can be any number from 2 to 254, except for 1. In this example, we are using 192.168.168.160 as the static IP Address.

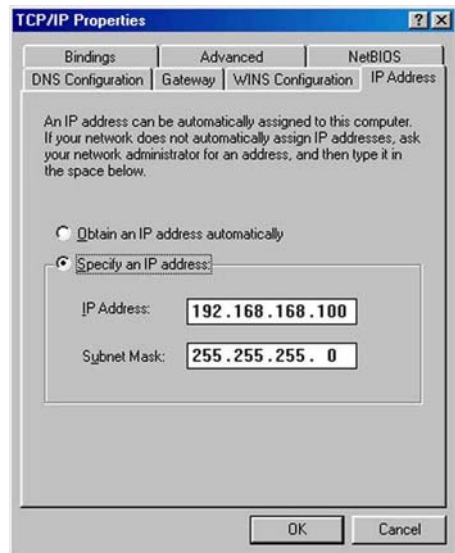

Step 5:

In order to check if the IP address has been assigned correctly to your PC, simply go to the **Start**

menu, select **Run**, and enter the command *wiipcfg*.

Select your respective Ethernet Adapter from the drop down list and click **OK**.

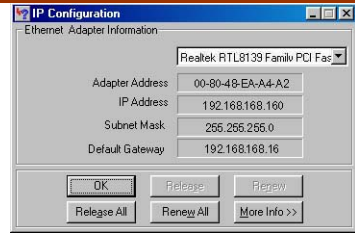

Now, your PC is now ready to communicate with your access point.

FOR WINDOWS XP/2000

Step 1:

Go to your desktop, right-click on **My Network Places** icon and select **Properties**.

Step 2:

Go to your network adapter icon, right click and select to **Properties**.



Step 3:

Highlight **Internet Protocol (TCP/IP)** and click on **Properties** button.

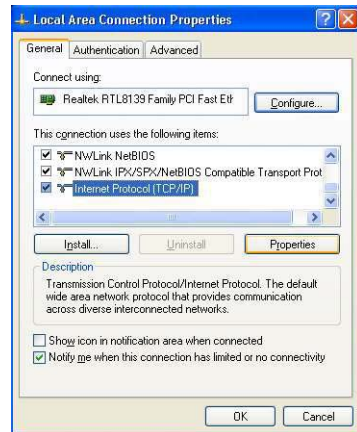

Step 4:

Select the radio button for **Use the following IP address**. Enter the IP Address and Subnet Mask as 192.168.168.X and 255.255.255.0, where X can be any number from 2 to 254, except for 1. In this example, we are using 192.168.168.160 as the static IP Address.

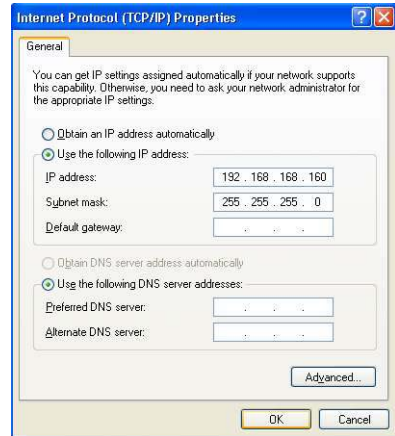

Step 5:

Click on **OK** to close all windows.

Step 6:

Next, in order to check if the IP address has been correctly assigned to your PC, go to **Start** menu, **Accessories**, select **Command Prompt** and type the command *ipconfig/all*.

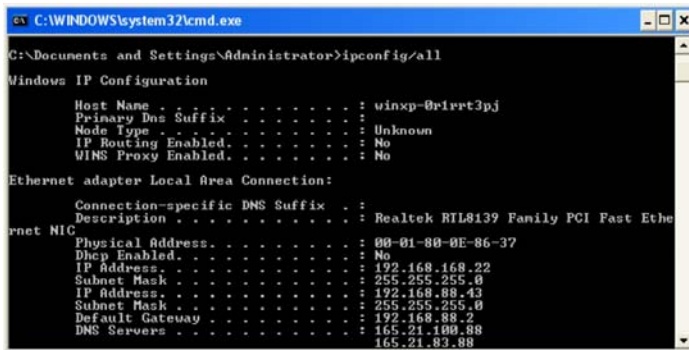

```
C:\WINDOWS\system32\cmd.exe
C:\Documents and Settings\Administrator>ipconfig/all

Windows IP Configuration

Host Name . . . . . : winxp-0r1rrt3pj
Primary Dns Suffix . . . . . :
Node Type . . . . . : Unknown
IP Routing Enabled. . . . . : No
WINS Proxy Enabled. . . . . : No

Ethernet adapter Local Area Connection:



   Connection-specific DNS Suffix  . :
   Description . . . . . : Realtek RTL8139 Family PCI Fast Eth
   eternet NIC
   Physical Address. . . . . : 00-01-80-0E-86-37
   Dhcp Enabled. . . . . : No
   IP Address. . . . . : 192.168.168.22
   Subnet Mask . . . . . : 255.255.255.0
   IP Address. . . . . : 192.168.88.43
   Subnet Mask . . . . . : 255.255.255.0
   Default Gateway . . . . . : 192.168.88.2
   DNS Servers . . . . . : 165.21.100.88
                           165.21.83.88
```

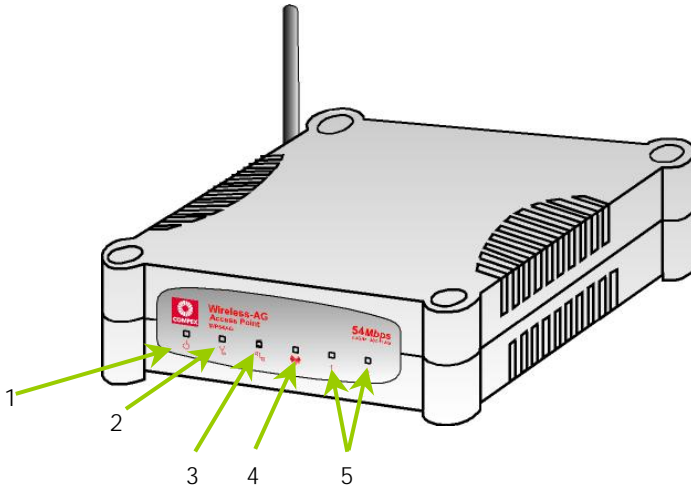

Your PC is now ready to communicate with your access point.

Appendix III: Panel Views & Descriptions

Front View of Access Point



	Name	Description	
1	 LED (Power)	Steady Blue	The device is powered up.
		Off	No power is supplied to the device.
2	 LED (Diagnostic)	Flashing Green	This indicates the flash during the power-up. The LED will goes off when the diagnostic is passed.
3	 LED (WAN Link/Act)	Steady Green	WAN connection is established.
		Flashing Green	Data transmission at WAN connection.

4	 LED (WLAN Link/Act LED)	Steady Green	Wireless interface up and running. Ready for operation.
		Flashing Green	Activity is detected in the wireless network.
5	 LED (Port 1 & 2 LEDs)	Steady Green	Connection has been established between the device and the network.
		Flashing Green	Activity is detected in the network.
		Off	No network connection.

Back View of Access Point

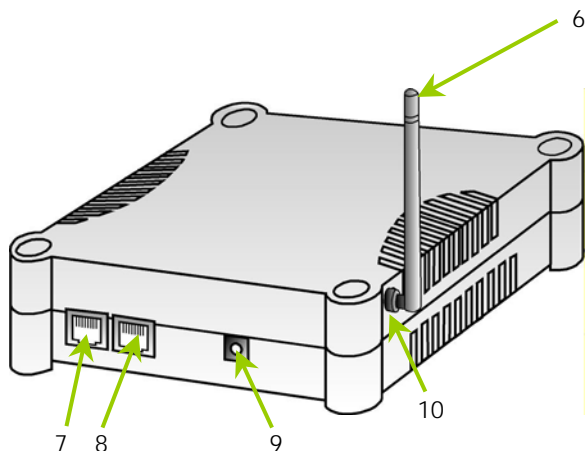

	Name	Description
6	External Antenna	SMA antenna
7	Ethernet Port 2	Connection for computer with NIC (Network Interface Card) or Ethernet network card.

8	Ethernet Port 1	Connection for computer with NIC (Network Interface Card) or Ethernet network card. If using PoE, connect to this port - Ethernet Port 1.
9	DC jack	Power Input
10	Reverse SMA connector	To attach external antenna

Bottom View of Access Point

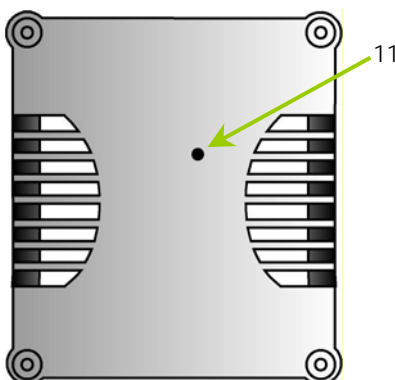

	Name	Description
11	Reset Push button	To reboot, press once. To reset password, press and hold the button for 5 seconds. The DIAG light will flash fast for about 5 flashes/sec before releasing the button. To restore the factory default settings, press and hold the button for more than 10 seconds. The DIAG light will flash slowly for about 10 flashes/sec before releasing the button.

Appendix IV: Command Line Interface Commands

Get Operation List

SYNTAX	DESCRIPTION
Get tasks	Display all active process/tasks.
Get sysinfo	Display system information.
Get ap1ist	Display list of access points discovered.
Get athstats	Display wireless driver information.
Get brinfo	Display bridge and interfaces information.
Get brmacshow	Display bridge learned MAC address list.
Get bssinfo.	Display current radio information.
Get channel	Display current wireless channel number.
Get chanlist	Display current domain wireless channels.
Get ieee80211stats	Display ieee80211 protocol statistics.
Get routeshow	Display the routing table information.
Get stalist	Display a list of currently associated stations.
Get linkinfo	Display client link information (Client mode only)
Get macstats	Display a list of currently learnt wireless device MAC addresses.
Get opmode	Display current wireless operation mode.
Get wmode	Display wireless mode (a/b/g)

Set Operation List

SYNTAX	DESCRIPTION
Set factorydefault	Set factorydefault - restore configuration to factory default.
Restart	Do a warm reboot.

Save Configuration

SYNTAX	DESCRIPTION
Commit	Save current configuration to flash. Most commands require rebooting to take effect after saving.

Long Range

Check for recommended values from long distant option setup page.

SYNTAX	DESCRIPTION
Set outdoor <enable/disable>	Enable outdoor for long-range connection.
Set distance <value>	Set the connection distant (value in decimal)
Set acktimeout <value>	Set the ACK timeout (value in decimal)
Set ctstimeout <value>	Set the CTS timeout (value in decimal)
Set slottimeout <value>	Set the Slot timeout (value in decimal)

TX Power

SYNTAX	DESCRIPTION
Set txpower <string>	(Default full) auto, 1, 2, 3, 4, ..., 17, full, min

TX Rate

SYNTAX	DESCRIPTION
Set txrate <string>	Values are: (default auto) (802.11a)-- 6, 9, 12, 18, 24, 36, 48, 54, auto (802.11b/g mixed)-- 1, 2, 5.5, 11, 6, 9, 12, 18, 24, 36, 48, 54, auto (802.11b-only)-- 1, 2, 5.5, 11, auto

Wireless Mode

SYNTAX	DESCRIPTION
Set wirelessmode <string>	Supported strings are: auto, 11a, 11b, 11g, pureg, superg, supera
Set autochannelselect Enable/disable	Enable or disable smart channel select during power up.
Set radio_off_eth_down enable/disable	Enable or disable auto turn off radio when Ethernet port connection link is lost.

WEP Key

Must first, set a key entry type then proceed to set the key index, size and value.

SYNTAX	DESCRIPTION
Set key <keyindex> <keysize> <keyvalue>	Set keyentrymethod hex/ascii
Set key <keyindex> default	Set default key.

Add or Delete User

SYNTAX	DESCRIPTION
Set user < [-r] -w > <password> username	To add a user.
Set user -d username	To delete user.

Country Code

SYNTAX	DESCRIPTION
Set countrycode <iso.name>	List of countries:
Set countrycode <2 letter string>	{0, "NA"}, {CTRY_ALBANIA, "AL"}, {CTRY_ALGERIA, "DZ"}, {CTRY_ARGENTINA, "AR"}, {CTRY_ARMENIA, "AM"}, {CTRY_AUSTRALIA, "AU"}, {CTRY_AUSTRIA, "AT"}, {CTRY_AZERBAIJAN, "AZ"}, {CTRY_BAHRAIN, "BH"}, {CTRY_BELARUS, "BY"}, {CTRY_BELGIUM, "BE"}, {CTRY_BELIZE, "BZ"}, {CTRY_BOLIVIA, "BO"}, {CTRY_BRAZIL, "BR"}, {CTRY_BRUNEL_DARUSSALAM, "BN"}, {CTRY_BULGARIA, "BG"}, {CTRY_CANADA, "CA"}, {CTRY_CHILE, "CL"}, {CTRY_CHINA, "CN"}, {CTRY_COLOMBIA, "CO"}, {CTRY_COSTA_RICA, "CR"}, {CTRY_CROATIA, "HR"}, {CTRY_CYPRUS, "CY"}, {CTRY_CZECH, "CZ"}, {CTRY_DENMARK, "DK"}, {CTRY_DOMINICAN_REPUBLIC, "DO"}, {CTRY_ECUADOR, "EC"},

	{CTRY_EGYPT, "EG"}, {CTRY_EL_SALVADOR, "SV"}, {CTRY_ESTONIA, "EE"}, {CTRY_FINLAND, "FI"}, {CTRY_FRANCE, "FR"}, {CTRY_FRANCE2, "F2"}, {CTRY_GEORGIA, "GE"}, {CTRY_GERMANY, "DE"}, {CTRY_GREECE, "GR"}, {CTRY_GUATEMALA, "GT"}, {CTRY_HONDURAS, "HN"}, {CTRY_HONG_KONG, "HK"}, {CTRY_HUNGARY, "HU"}, {CTRY_ICELAND, "IS"}, {CTRY_INDIA, "IN"}, {CTRY_INDONESIA, "ID"}, {CTRY_IRAN, "IR"}, {CTRY_IRELAND, "IE"}, {CTRY_ISRAEL, "IL"}, {CTRY_ITALY, "IT"}, {CTRY_JAPAN, "JP"}, {CTRY_JAPAN1, "J1"}, {CTRY_JAPAN2, "J2"}, {CTRY_JAPAN3, "J3"}, {CTRY_JAPAN4, "J4"}, {CTRY_JAPAN5, "J5"}, {CTRY_JAPAN6, "J6"}, {CTRY_JORDAN, "JO"}, {CTRY_KAZAKHSTAN, "KZ"}, {CTRY_KOREA_NORTH, "KP"}, {CTRY_KOREA_ROC, "KR"}, {CTRY_KOREA_ROC2, "K2"}, {CTRY_KOREA_ROC3, "K3"}, {CTRY_KUWAIT, "KW"}, {CTRY_LATVIA, "LV"}, {CTRY_LEBANON, "LB"}, {CTRY_LIECHTENSTEIN, "LI"}, {CTRY_LITHUANIA, "LT"}, {CTRY_LUXEMBOURG, "LU"}, {CTRY_MACAU, "MO"}, {CTRY_MACEDONIA, "MK"}, {CTRY_MALAYSIA, "MY"}, {CTRY_MALTA, "MT"}, {CTRY_MEXICO, "MX"}, {CTRY_MONACO, "MC"}, {CTRY_MOROCCO, "MA"}, {CTRY_NETHERLANDS, "NL"}, {CTRY_NEW_ZEALAND, "NZ"}, {CTRY_NORWAY, "NO"}, {CTRY_OMAN, "OM"}, {CTRY_PAKISTAN, "PK"}, {CTRY_PANAMA, "PA"}, {CTRY_PERU, "PE"}, {CTRY_PHILIPPINES, "PH"}, {CTRY_POLAND, "PL"}, {CTRY_PORTUGAL, "PT"}, {CTRY_PUERTO_RICO, "PR"}, {CTRY_QATAR, "QA"}, {CTRY_ROMANIA, "RO"}, {CTRY_RUSSIA, "RU"}, {CTRY_SAUDI_ARABIA, "SA"}, {CTRY_SINGAPORE, "SG"}, {CTRY_SLOVAKIA, "SK"}
--	---

	<pre>{CTRY_SLOVENIA, "SI" }, {CTRY_SOUTH_AFRICA, "ZA" }, {CTRY_SPAIN, "ES" }, {CTRY_SWEDEN, "SE" }, {CTRY_SWITZERLAND, "CH" }, {CTRY_SYRIA, "SY" }, {CTRY_TAIWAN, "TW" }, {CTRY_THAILAND, "TH" }, {CTRY_TRINIDAD_Y_TOBAGO, "TT" }, {CTRY_TUNISIA, "TN" }, {CTRY_TURKEY, "TR" }, {CTRY_UKRAINE, "UA" }, {CTRY_UAE, "AE" }, {CTRY_UNITED_KINGDOM, "GB" }, {CTRY_UNITED_STATES, "US" }, {CTRY_URUGUAY, "UY" }, {CTRY_UZBEKISTAN, "UZ" }, {CTRY_VENEZUELA, "VE" }, {CTRY_VIET_NAM, "VN" }, {CTRY_YEMEN, "YE" }, {CTRY_ZIMBABWE, "ZW" },</pre>
--	---

Channel

SYNTAX	DESCRIPTION
Set channel <value>	(Value in decimal)

SSID

SYNTAX	DESCRIPTION
Set ssid <string>	(Not More than 32 characters)

Closed System

SYNTAX	DESCRIPTION
Set hidessid enable/disable	Enable or disable broadcasting of SSID.

Per Node

SYNTAX	DESCRIPTION
Set apbridge enable/disable	Enable or disable isolation of wireless client.

RTS, Fragment, and Beacon Interval

SYNTAX	DESCRIPTION
Set rts <value>	(Value in decimal, default 2312, range 1 to 2312)
Set fragment <value>	(Value in decimal, default 2346, range, 256 to 2346)
Set beaconintval <value>	(Value in decimal, default 1, range 1 to 1000)
Set dtim <value>	Data Beacon Rate (value in decimal, default 1, range 1 to 16384)

WLAN State

SYNTAX	DESCRIPTION
Get wlanstate	Display whether status of current wireless operation is Enabled or Disabled.
Set wlanstate enable/disable	Set to Disable to turn off wireless operation. Set to Enable to turn back on wireless operation. Note: When executing this command, please ensure that you are not connected on wireless with device or you will be disconnected from the device and network. The wireless operation can only be Enabled from the Ethernet port or UTP cable connection to device.

Reset Button

SYNTAX	DESCRIPTION
Get buttonpassreset	Display the status of Reset Button operation. If status is (Enabled), resetting of password by pressing Reset Button is allowed. If status is (Disabled), resetting of password by pressing Reset Button is not allowed.
Set buttonpassreset enable/disable	Set to Disable to prevent resetting of password by pressing Reset button. Set to Enable to allow resetting of password by pressing Reset button.

Appendix V: Technical Specifications

Safety and Electromagnetic Conformance	<ul style="list-style-type: none"> • FCC Part 15 SubPart B and SubPart C (for wireless module) • EN 300 328-2 • EMC CE EN 301 489 (EN300 826) • EN 55022 (CISPR 22)/EN 55024 Class B • EN 61000-3-2 • EN61000-3-3 • CE EN 60950
Standards	<ul style="list-style-type: none"> • IEEE 802.11a • IEEE 802.11b • IEEE 802.11g
Performance	<ul style="list-style-type: none"> • Network speeds dynamically shift between 1,2, 5.5, 11, 12, 18, 24, 36, 48, 54 Mbps • Indoor: 20 m (54 Mbps) • Outdoor: 80 m (54 Mbps)
Frequency Range	<ul style="list-style-type: none"> IEEE 802.11b: 2.4 ~ 2.4835 GHz IEEE 802.11g: 2.4 ~ 2.497 GHz IEEE 802.11a: 5.180 ~ 5.825 GHz
Wireless Modes Operation	<ul style="list-style-type: none"> • Access Point • Access Point Client • Point to Point • Point to Multiple Point • Wireless Routing Client • Gateway • Wireless Adapter

Security	<ul style="list-style-type: none"> • 64 - bit / 128 - bit WEP • WPA-Enterprise, WPA-Personal, WPA2-Enterprise, WPA2-Personal, WPA-Auto-Enterprise, WPA-Auto-Personal • Pseudo Virtual LAN • Tagged VLAN • IEEE 802.1x – TLS, TTLS, PEAP, EAP-SIM • Wireless MAC address filtering (in Access Point mode)
Network Interface	2 10/100 Mbps auto-negotiating Ethernet ports (RJ45)
Modulation Techniques	OFDM (BPSK, QPSK, 16-QAM, 64-QAM), DSSS (BPSK, QPSK, CCK)
Output Power IEEE 802.11a: IEEE 802.11b: IEEE 802.11g:	18 dBm 20 dBm 20 dBm
Operating Channels	<ul style="list-style-type: none"> • 11 Channels (US and Canada) • 13 Channels (Europe) • 14 Channels (Japan)
Advanced Wireless Features	<ul style="list-style-type: none"> • Wireless Distribution System (WDS) • Long Distance Parameters Setup • Wireless Pseudo VLAN <ul style="list-style-type: none"> - Per Node - Per Group - Tagged VLAN pass-through • Adjustable transmit power control (in 1dB steps) • Smart Select • STP • HTTPS
Antenna	Detachable 2dBi antenna with SMA connector

Management	<ul style="list-style-type: none"> • HTTP Web Management • SNMP <ul style="list-style-type: none"> - SNMP (RFC1157) - SNMP (RFC1213) • Telnet • SSH • Syslog
Built-in DHCP Server	Yes
DHCP Reservation	By MAC address
Configuration Backup & Restore	Yes
Firmware Upgrade	Yes
Power Requirements	
Using Power Adapter:	Output 24VDC –48VDC (localized to country of sale)
Using PoE:	802.11af PoE
Cable Length Requirement for PoE	100 meters (max)
Environment Requirements	
Operating Temp:	-20°C to +70°C
Storage Temp:	-65°C to +100°C
Operating Humidity:	5% to 95% RH
	Humidity (RH – Relative Humidity):
Physical Dimensions	145mm x 132mm x 41mm (H x W x D)